

EIFFER

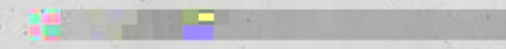

MACHINES ET MOULES

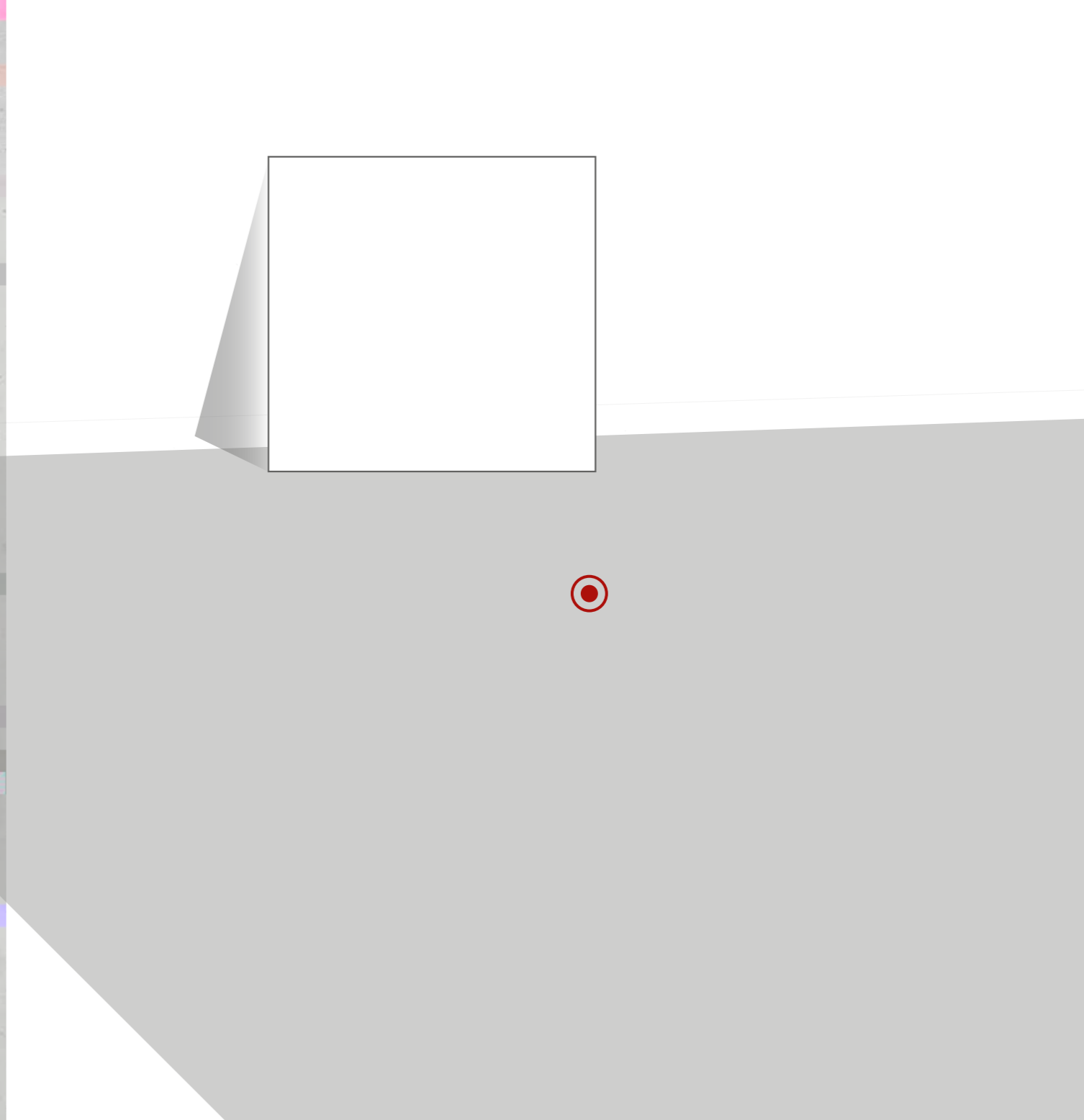
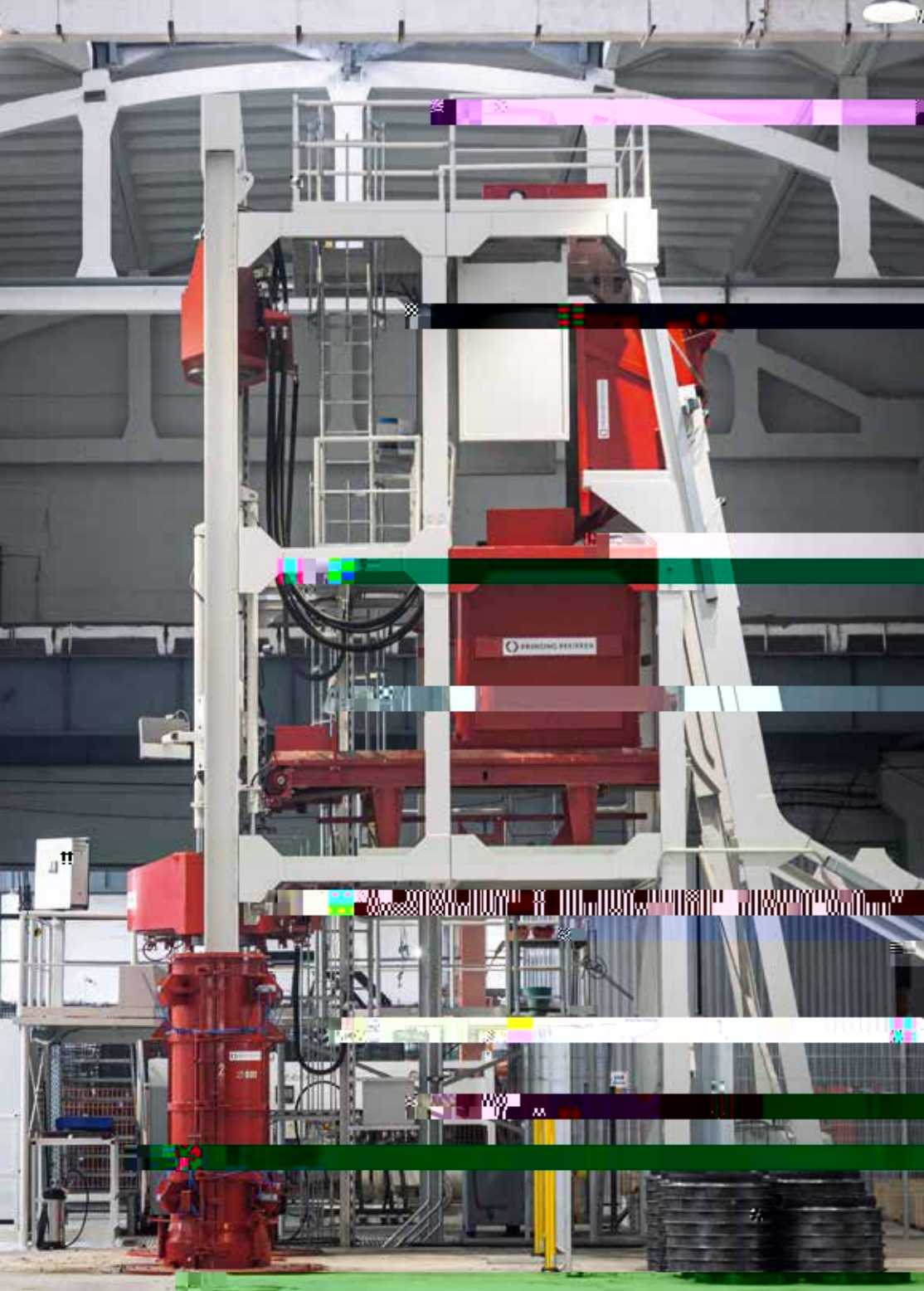

NOTRE
VISION

Cdiğ`k`h`dc`X] Zo`EG:CO:C<`E; : *; : : G`Zhi`Y iğ`z`z`z`VYZg`b dcY`Va`YZ`a`ccdkVi`dc`Zc`
b Vi`^`ğ`YZ`b`VX] ėZ`h`Zi`Y iğ`d`g [ėcXZ`Zc`b Vi`^`ğ`Y ZnXZa`cXZ`YVch`d`[WgXVi`dc`
YZ`egYj ĩh`Zc`Widc#; V dccZgYZh`egVi`fj Zh`Yj gWz`h`YZh`iZX] cda`\`Zh`YZ`ed`ciZ`Zi`
j c`Zc`\\Zb Zci`hVch`ğ`a X] Z`edj g`d`fj Va`# : c`[VkdghVci`j cZ`Xj aj ė`Y Vb` adgVi`dc`
Xdc`i`ej Z`Zi`YZ`Xda`Wdgi`dc`i`cdj h`hdj] V`dch`eZğ` Ziiğ` ė`cdh`XaZcih`Zi`eVgZcV`ğ`h
YZ`aW`ğ`ğ`zj ė`ea`c`ediZci`Za`Zi`Y Vhhj ė`g`a`ccdkVi`dc`V`ch`^`fj Z`z`h`j XX`h`edj ė`z`h`
générations futures.

NOTRE
MISSION

Cdiğ` d[[ğ` YZ` hZg`XZ` Xdb ea iZ` Zi` cdh` egYj ĩh` cj b` ėfj Zh` ėcdkVcih
XdcigVY`Zci` `XZ`fj Z`kdh`b`VX] ėZ`h`Zi` ėchi`Va`Vi`dc`h`[dcXi`dc`cZci`idj`_dj`ğ`h`YZ`
b Vc`^`ğ`dei`b`Va`#`Fj` ĩh`V`h`hZ`YZ`ğ`i`ğ` i`h`YZ`XdchZ`h`h`j ė`z`h`e`^`XZ`h`YZ`
ğ`X] Vc`Z`dj`YZ`XdchZ`h`Vj`m`XaZcih`h`j ė`ea`XZ`!`cdiğ`eZğ`d`ccZa`[dğ` `Zhi`
`kdiğ`Y`hedh`^`dc` `idj`i`b`db`Zci`#`6kZ`h`b`VgEVg`h`Zi`h`b`Vg8] ZX`!
cdj`h`kdj`h`egledhdch`Zc`dj`iğ`YZ`h`hdaj`i`dc`h`ė`ciZa`ZciZ`h`fj`^`
Vj`b`ZciZci`ZcXdğ`kdiğ`Z` XVX`^`Zi`kdiğ` V`W`at`#`

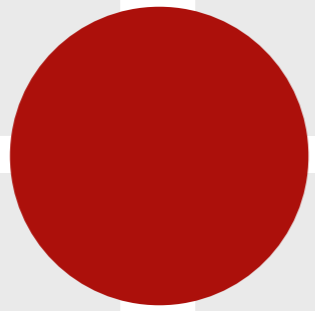

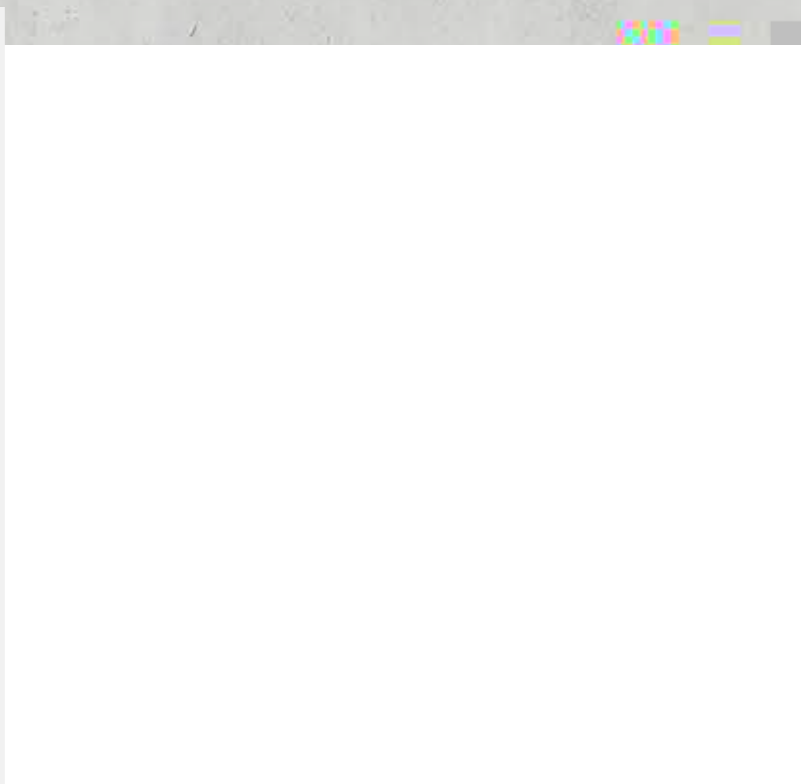
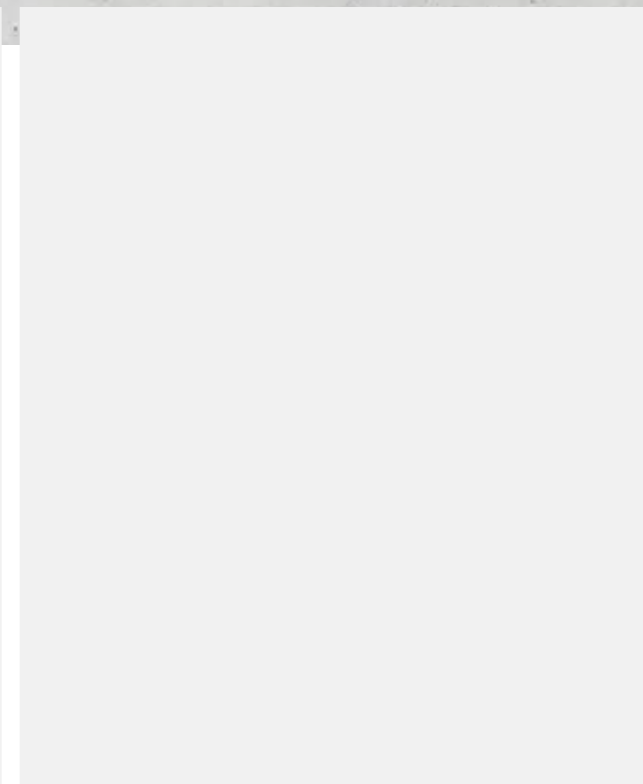
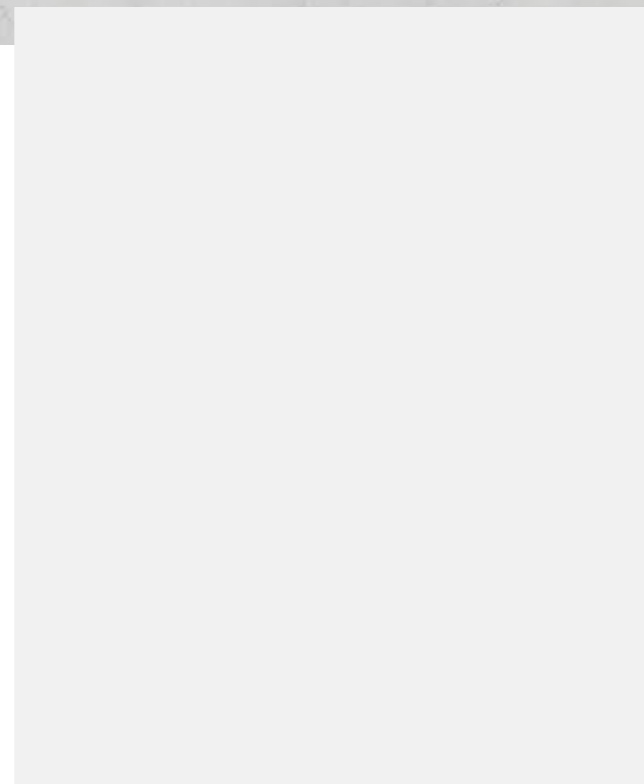
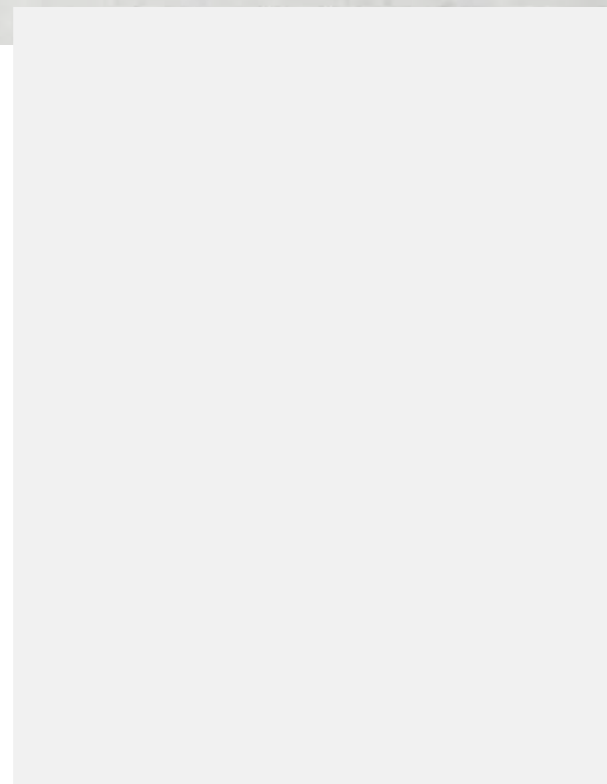
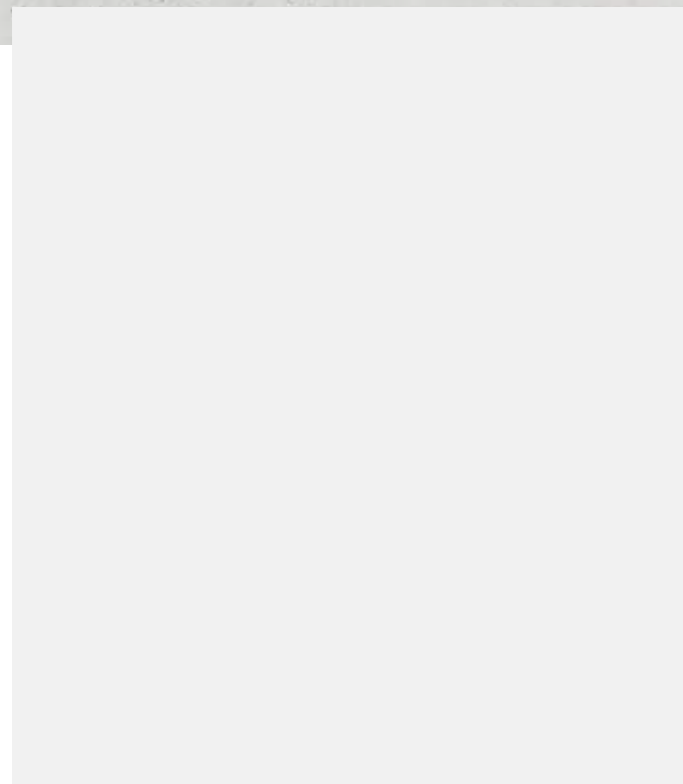

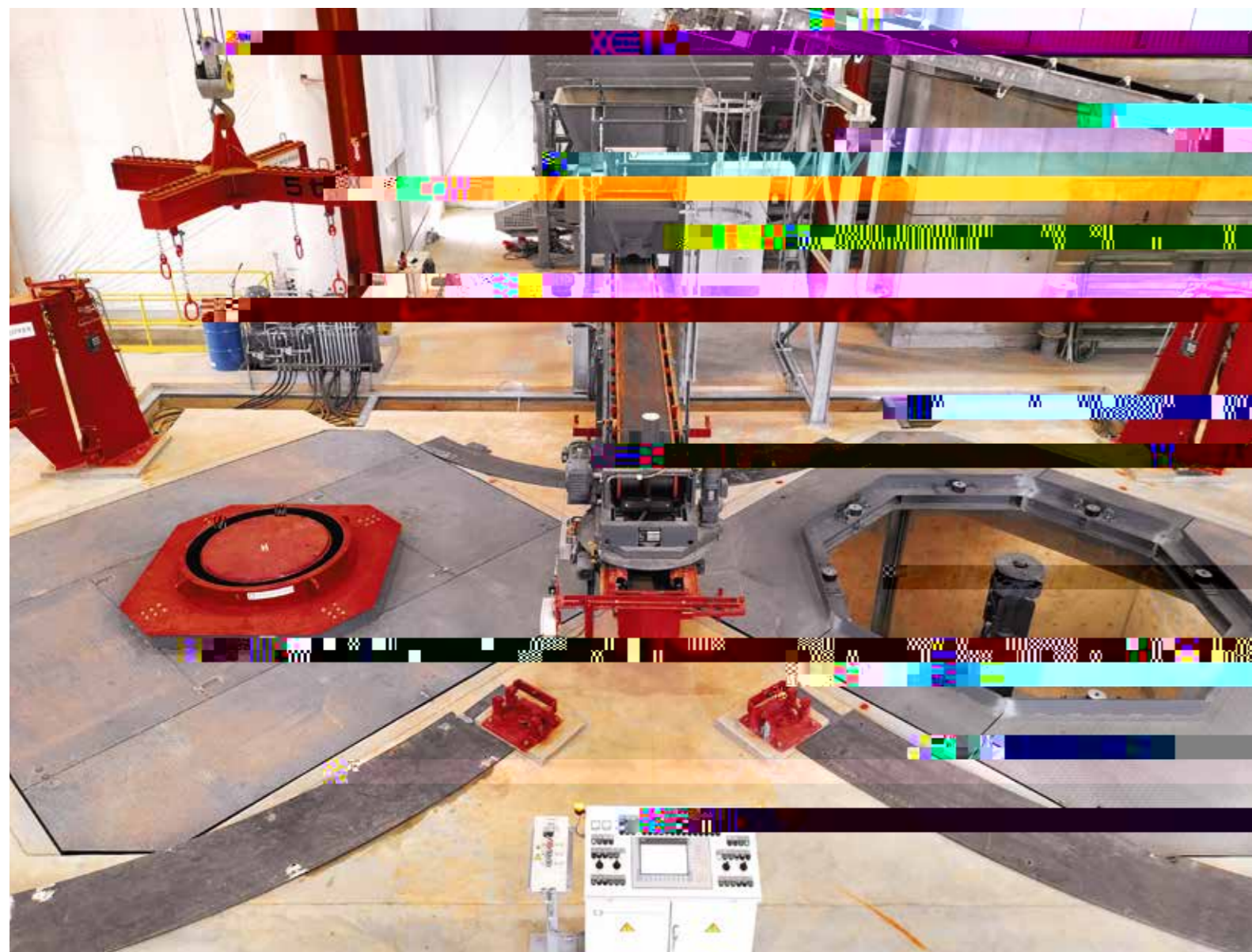

MACHINES ET MOULES

POUR LA FABRICATION DE TUYAUX,
DE REGARDS ET D'ÉLÉMENTS PRÉFABRIQUÉS EN BÉTON

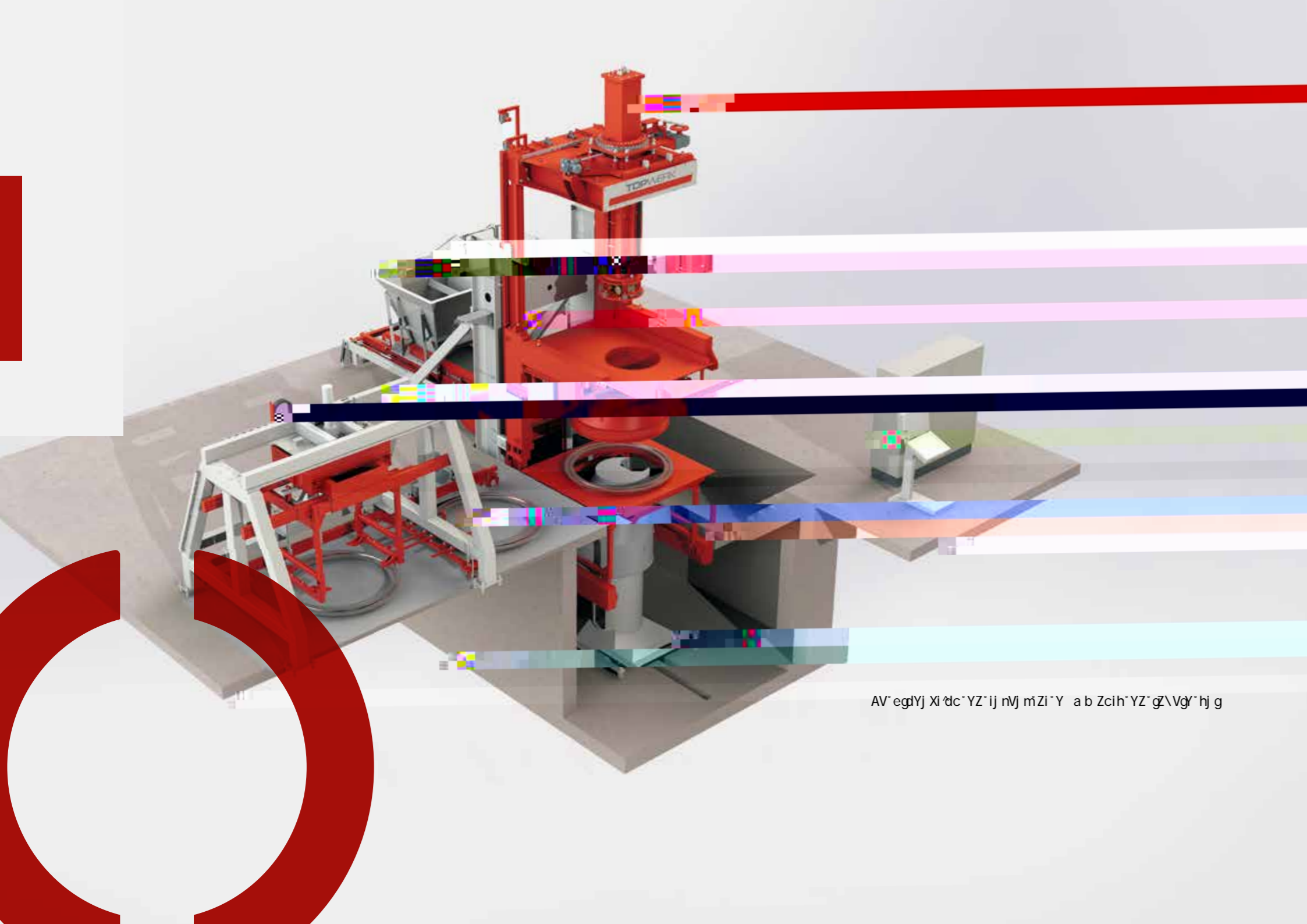

AV' egdYj Xi 'dc' YZ' ij nVj mZi 'Y a b Zcih' YZ' g'VgY' hj g

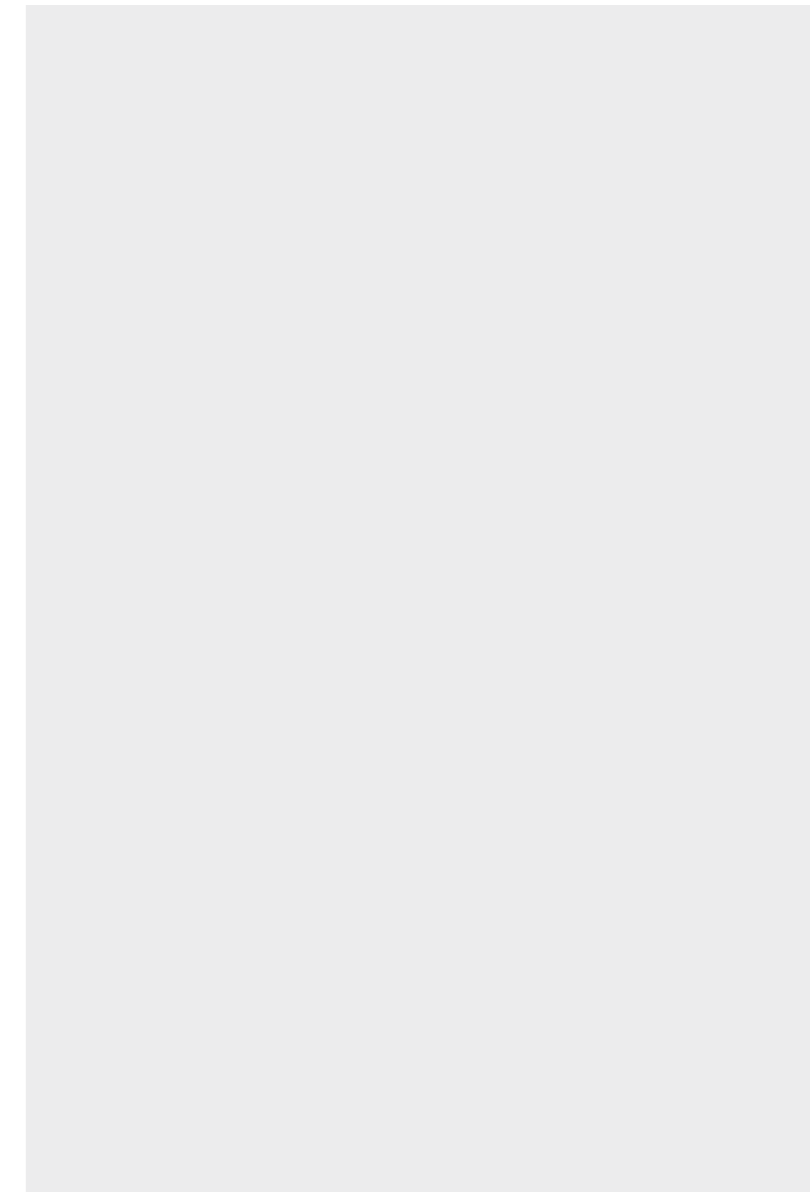

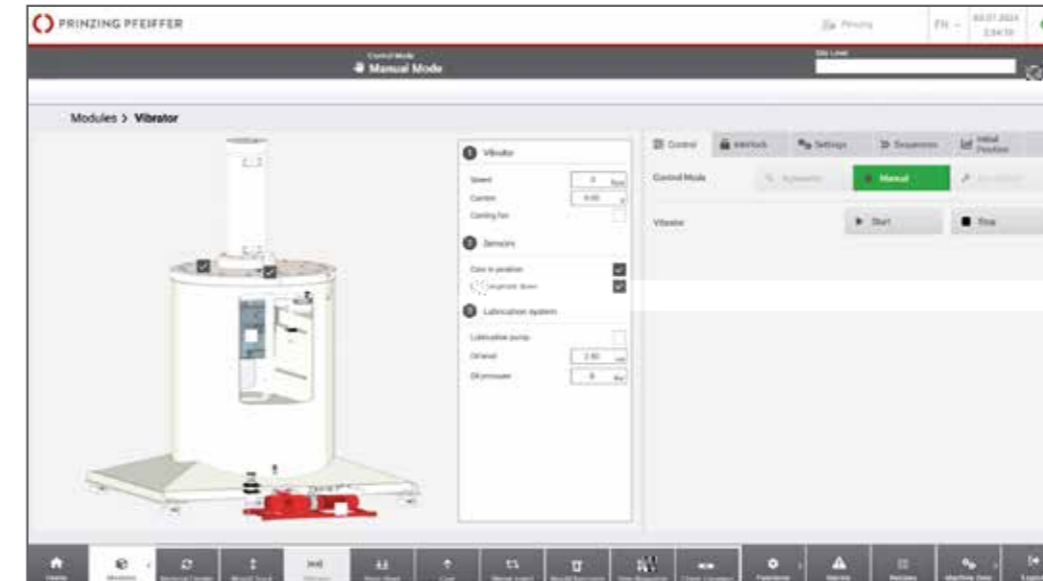
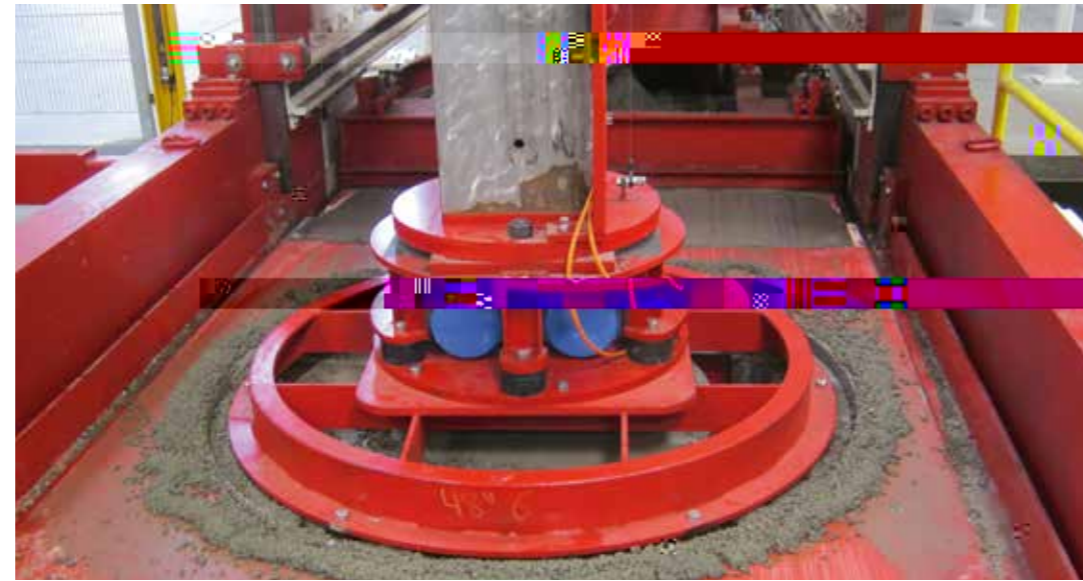

- CZiidn\Z'Vj idb Vi h' YZh'gicYZazh'YZ'WwhZ!'h'j k' de l'application d'un agent de démoulage
- 6ab ZciVi 'tc'Vj idb Vi f'j Z'YZ'h'gicYZazh'YZ'WwhZ!' des échelons ou des éléments de transport
- Vibration directe des échelons et/ou des éléments de transport
- G \a\Z'Vj idb Vi f'j Z'YZ'a'eg'zhz'edj gāzh'eg!Yj 'th' ZnXZcig h
- Compactage par vibreur vertical ou central
 - Production double ou combinée possible
 - j hfj Vj Y'Vb ig'cdb 'cVá+%%
- Consultation du déroulement de la production via des appareils mobiles
- Assistance en ligne avec accès direct au système de commande
- 9ViV'6cVanoZgZi 'g'eedgh'edj g la mise à disposition de toutes les Ydcc Zh'Zi hiVi hi f'j ZhYZ production pertinentes

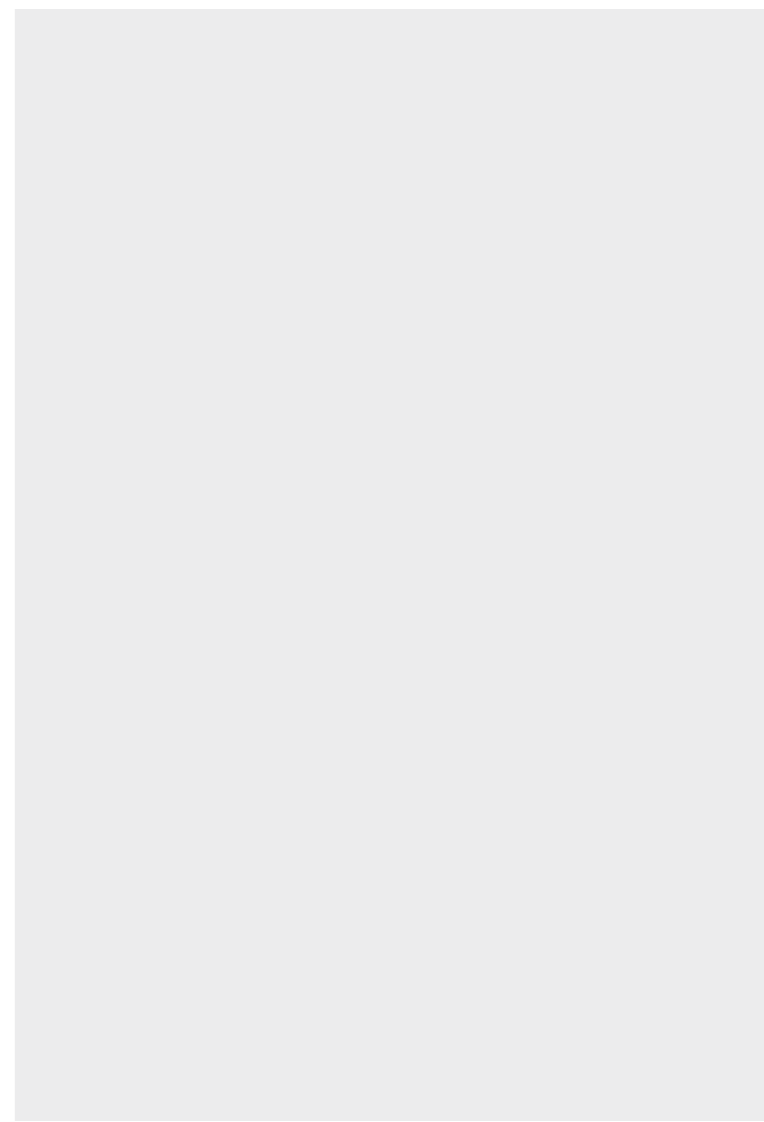
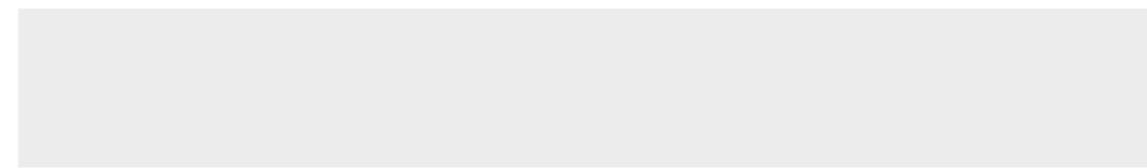
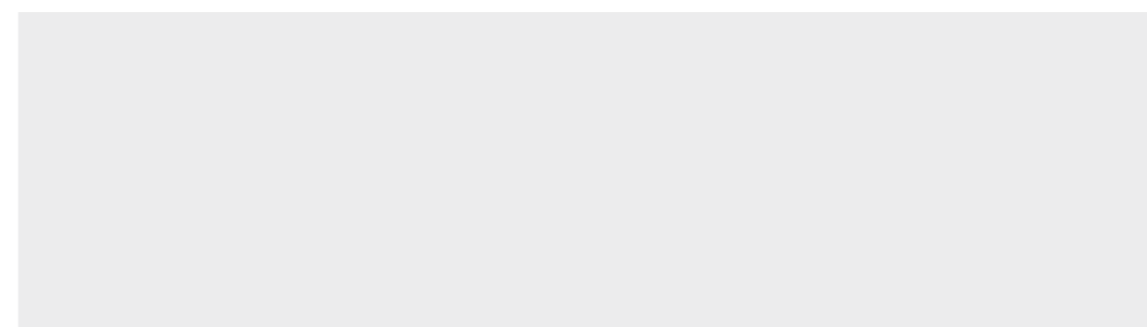
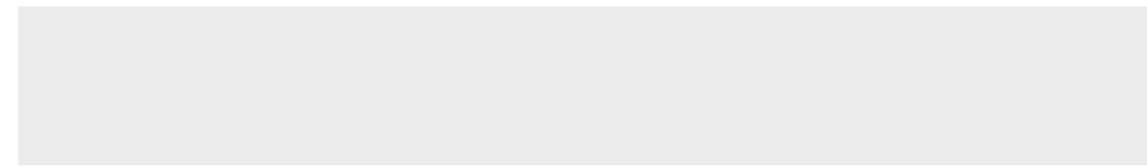
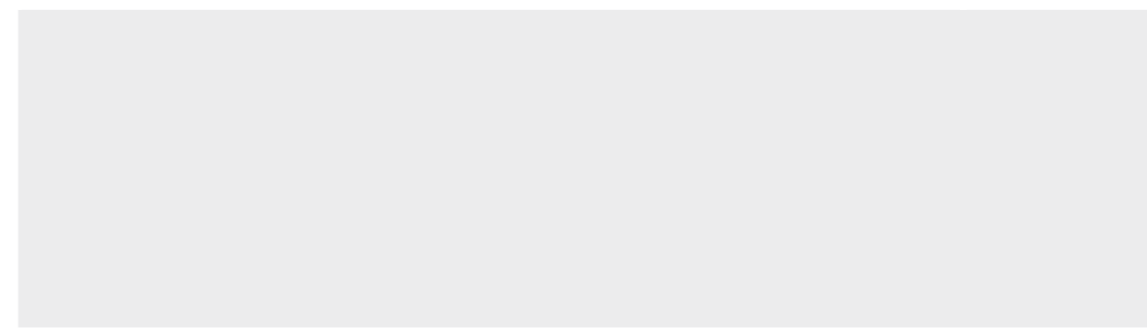
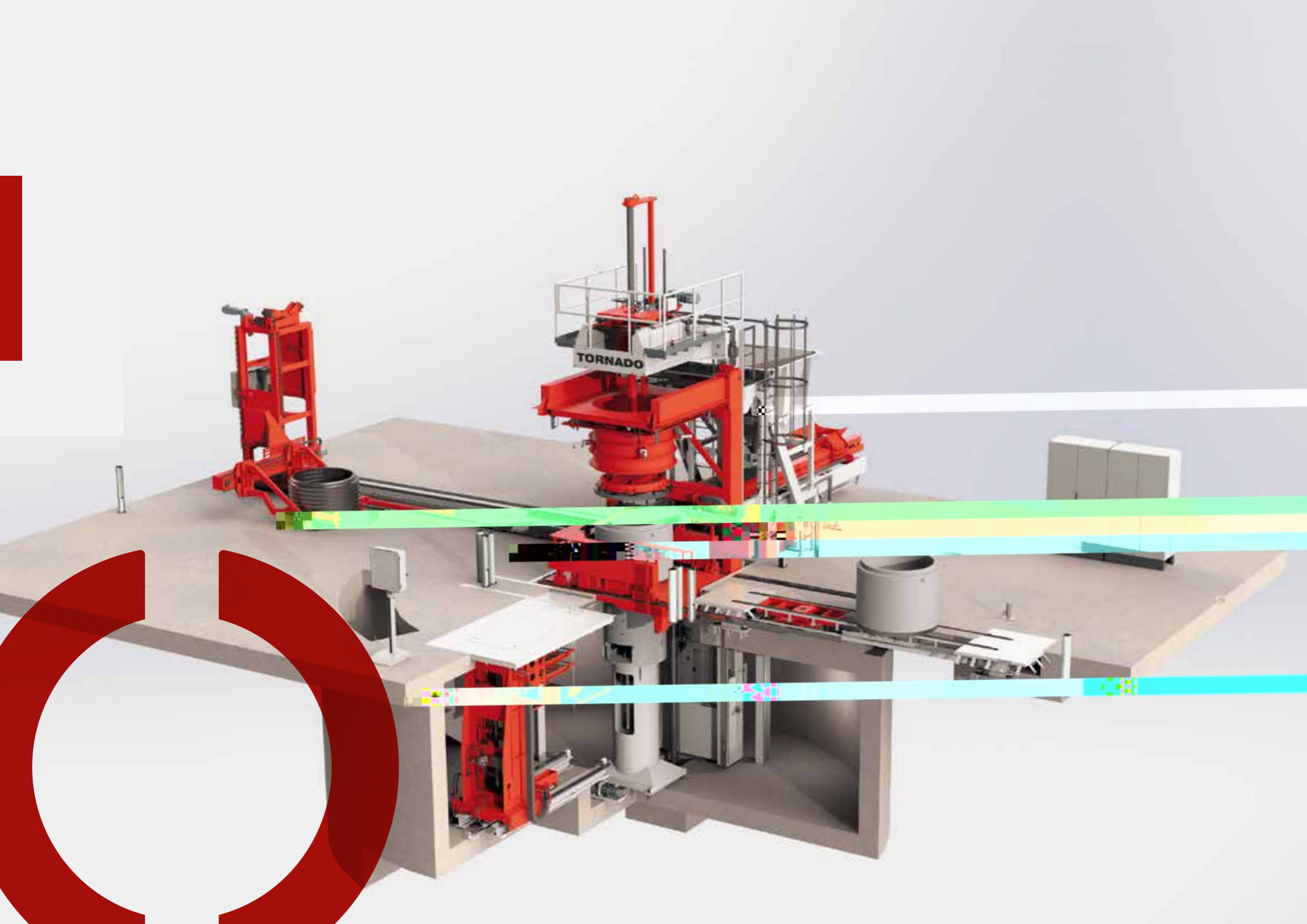

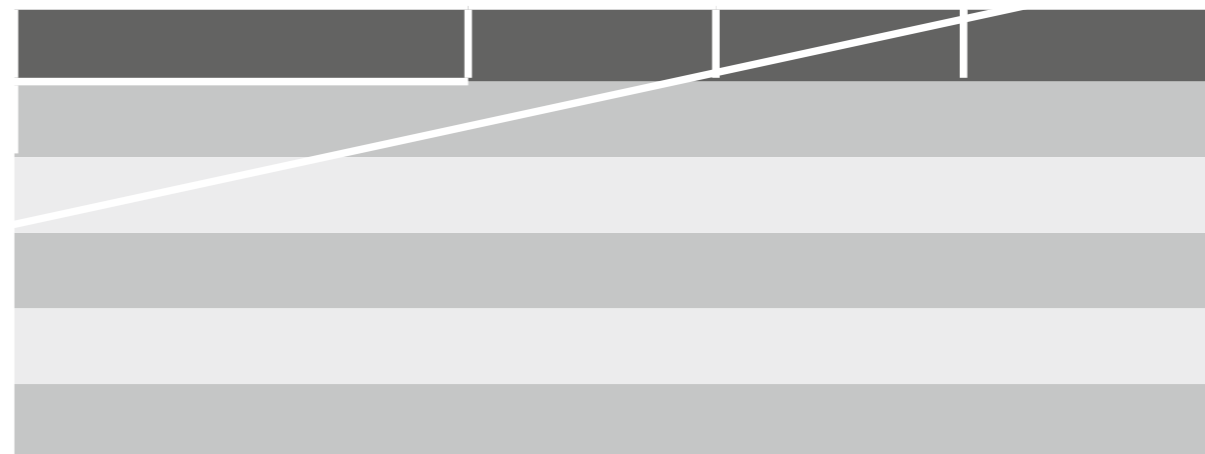

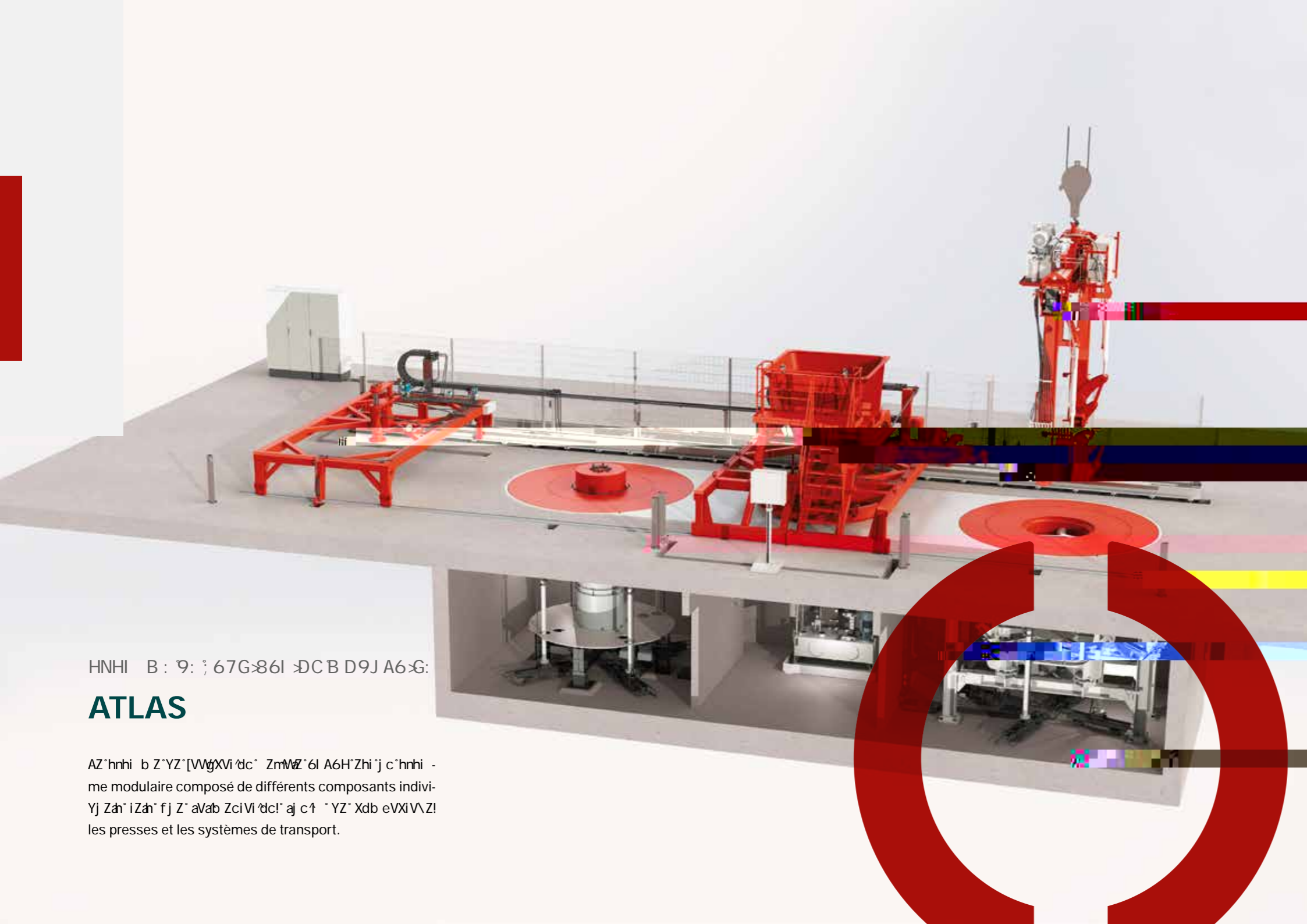

HNHI B : 9: ; 67G>86I >DC B D9J A6>G:

ATLAS

AZ*hrhi b Z*YZ*[WgXVi'dc' ZnMz'6I A6H'Zhi'j c'hrhi -
me modulaire composé de différents composants indivi-
Yj Zh' iZh' fj Z' aVab ZciVi'dcl' aj c† 'YZ' Xdb eVXiV\Z!
les presses et les systèmes de transport.

- 8db b VcYZ'hZb ^Vj idb Vi fj Z
- 8db eVXiV\Z'eVgk'WgZ gXZciq'adj 'kZg'XVa'g \j a 'Zc'lg fj ZcXZ
- HZgg^AZ] nYgJ afj Z'Yj 'b dj ā
- Fabrication des fonds avec traverse de retournement
 - Production en double
- 9ViV'6cVanoZgZi 'g'edg'c\ 'edj gā' 'b 'hZ' 'Y'hedh†'dc YZ'Idj iZh'āh'Ydcc Zh'Zi hiVi'hi' fj Zh'YZ'eg!Yj Xi'dc'eZg'cZciZh
- Smart Check pour un contrôle régulier et professionnel de votre installation

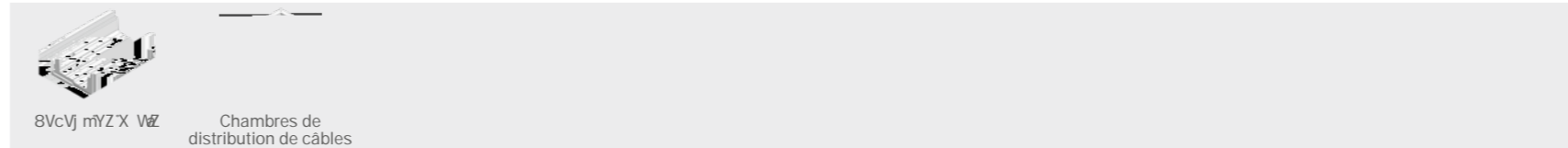
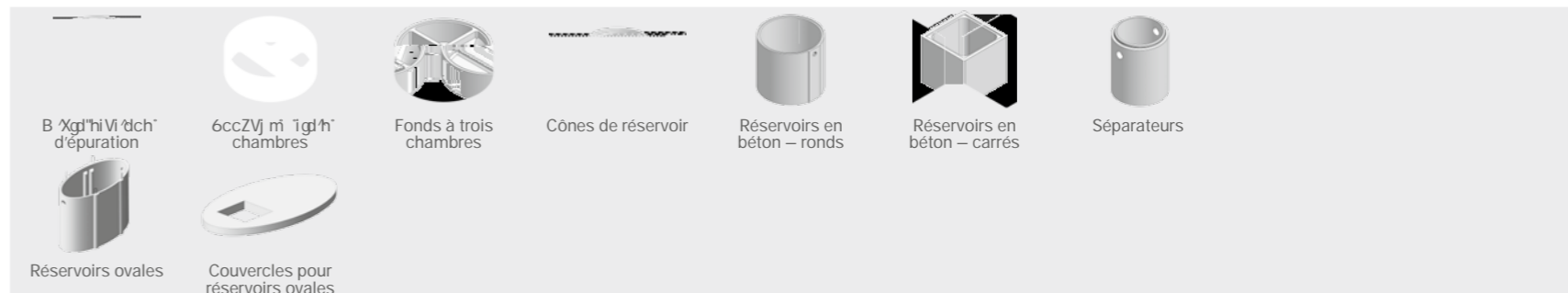
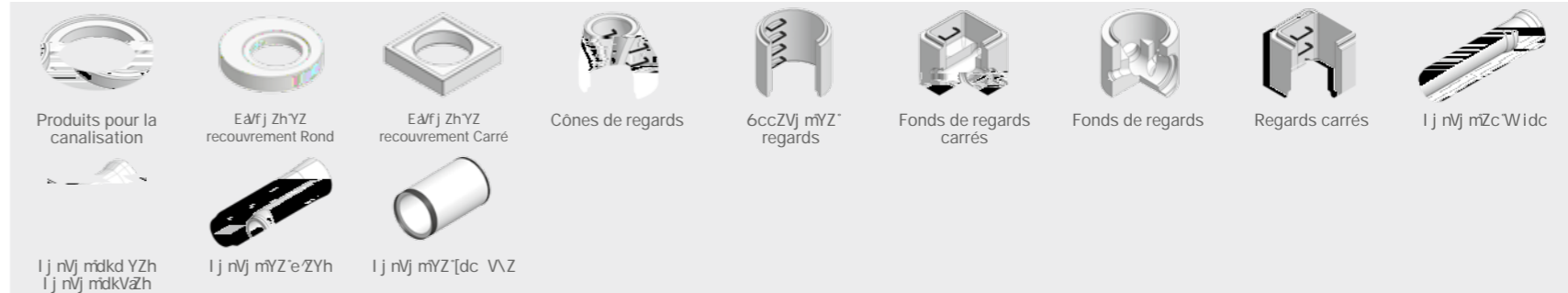
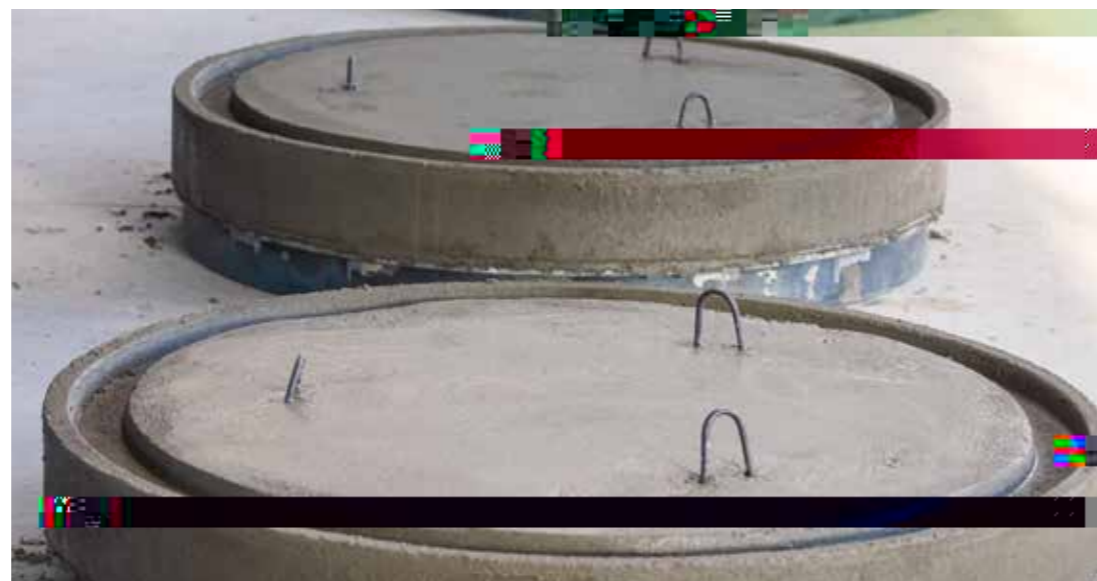



- 1 Appareil de levage avec presse
- 2 90°hedh††YZ'b dj áΛZ
- 3 9°higWY iZj g
- 4 Installation de chargement
- * Supports pour appareil de levage
- 6 Table vibrante
- 7 Appareil de commande
- 8 6ϕ d'ϕ' áXi g f j Z

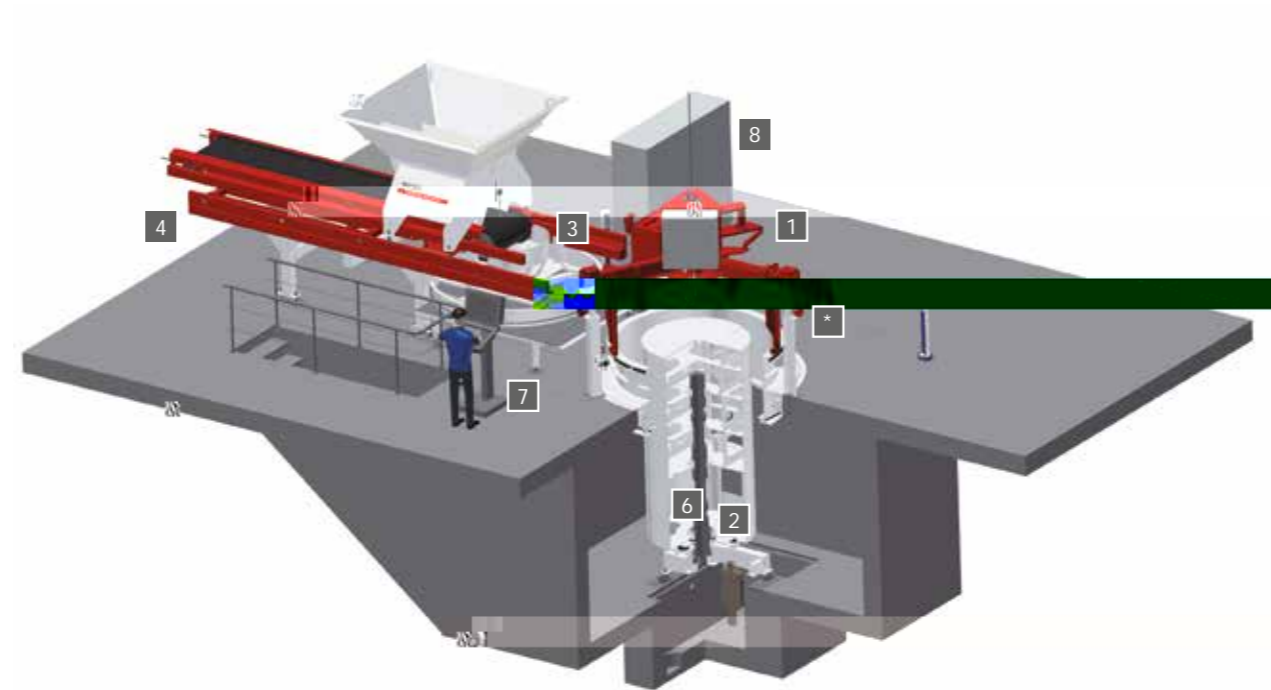

- 1 Appareil de levage avec presse
- 2 90°hedh††YZ'b dj áΛZ
- 3 9°higWY iZj g
- 4 Installation de chargement
- * Supports pour appareil de levage
- 6 Vibreur central
- 7 Appareil de commande
- 8 6ϕ d'ϕ' áXi g f j Z

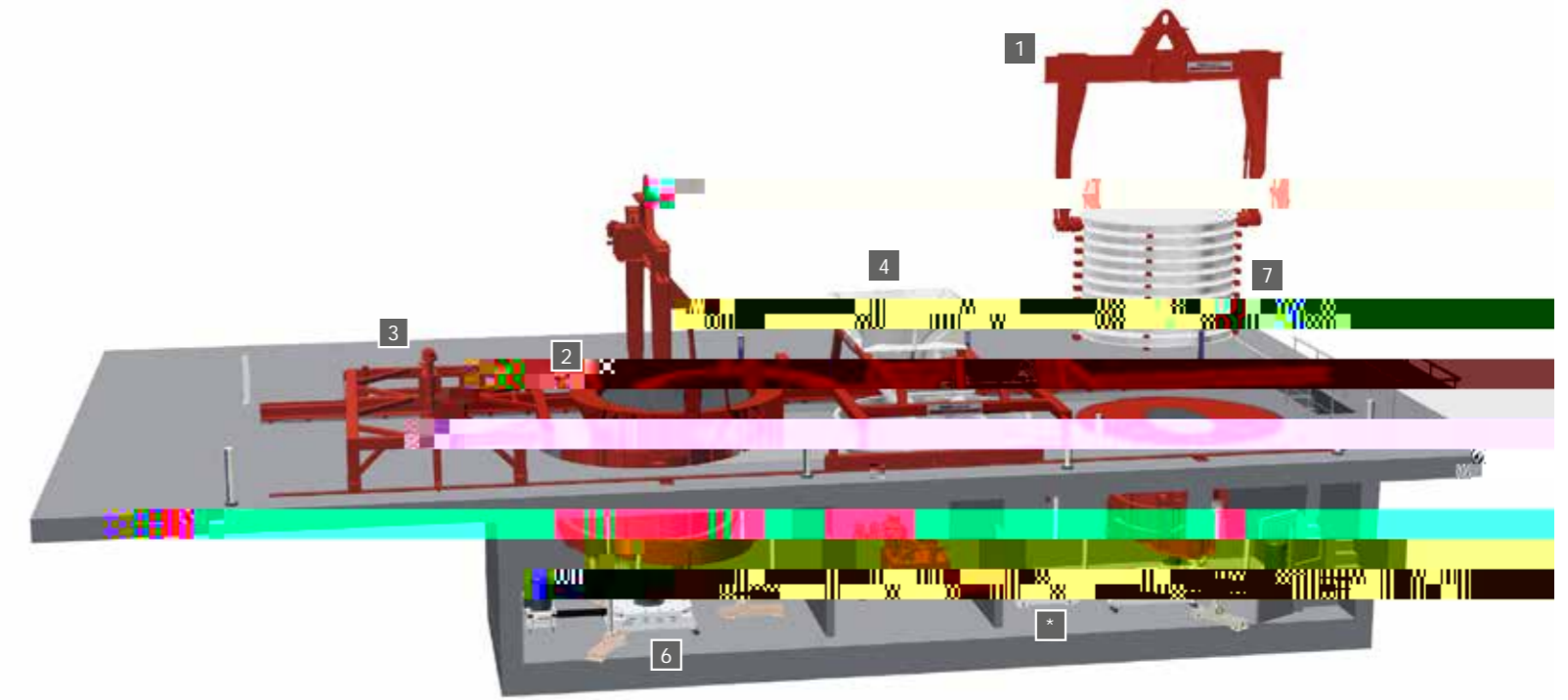

- 1 Traverse de retournement
- 2 90°hedh††YZ'b dj áΛZ
- 3 Presse linéaire
- 4 Installation de chargement
- * 90°hedh††Yfi_ZXi 'dc
- 6 Vibreur central
- 7 Palettes en acier

Procédé breveté pour la fabrication
 d'entrées et sorties associées pour
 les entrées et sorties associées pour

PRIMUSS 2.0

AVANTAGES :
 - Réduction des coûts de fabrication
 - Réduction des délais de livraison
 - Absence de coffrage et de raccords
 - Absence de traitement de surface

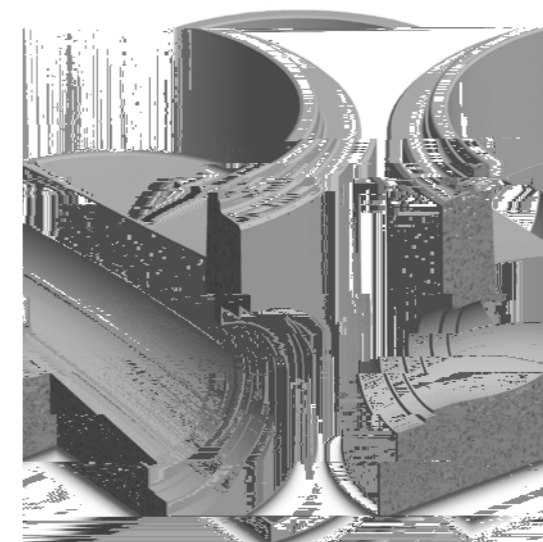
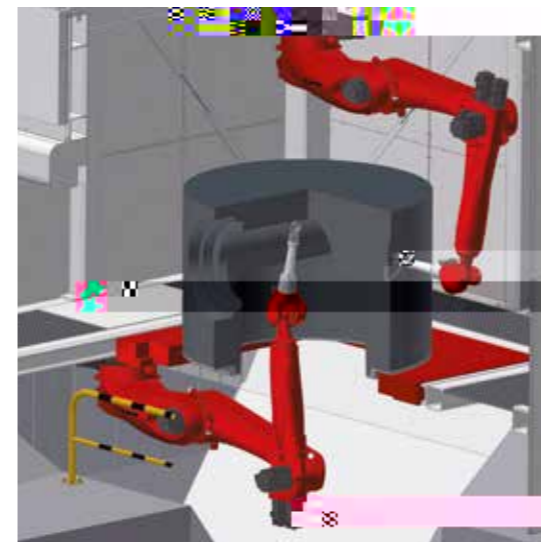
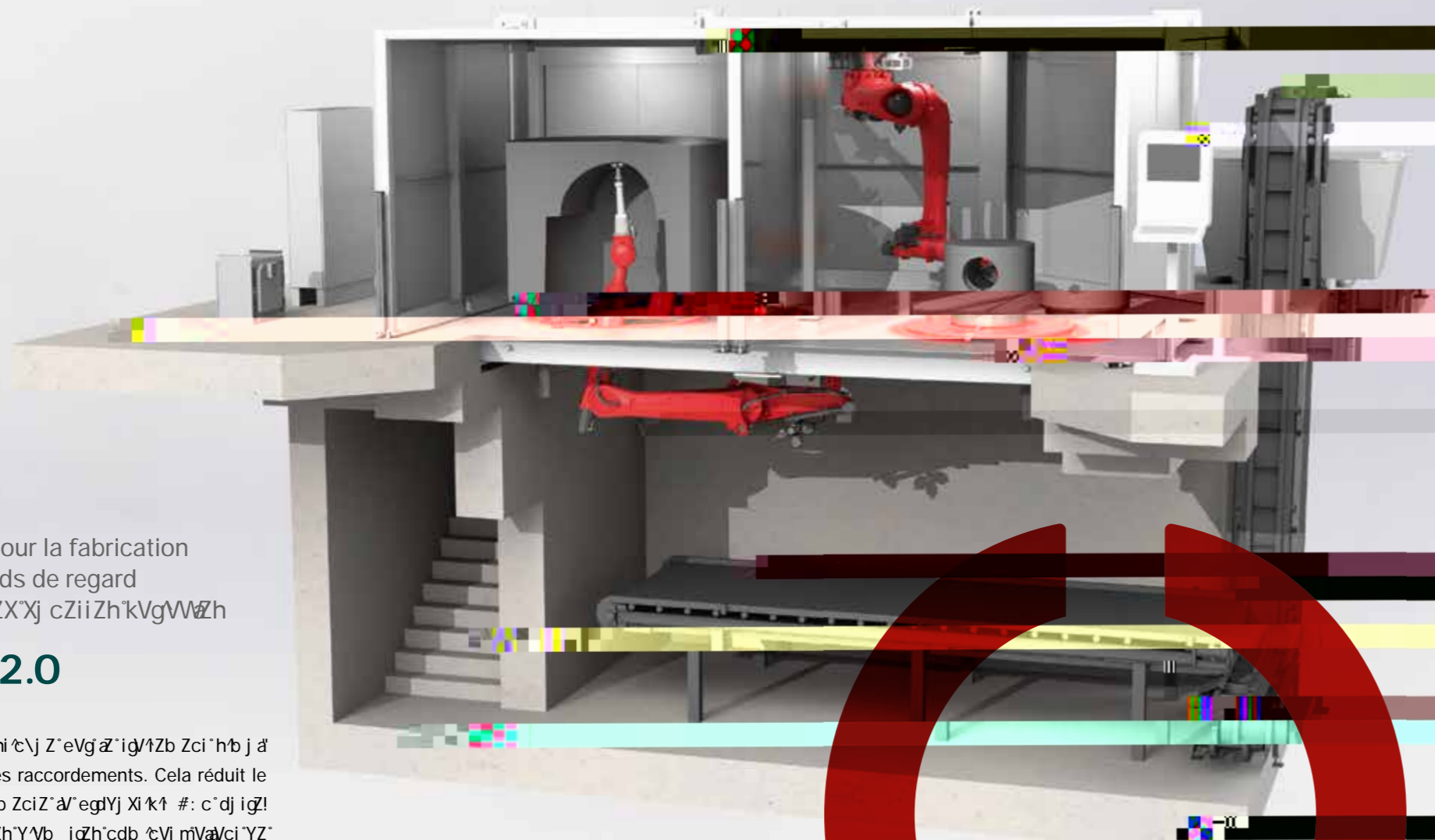

- Fabrication programmée de cunettes
 entrées et sorties associées pour
 les entrées et sorties associées pour
 - Conception de cunettes optimisée
- Absence d'éléments de coffrage et
 de raccords
 - Absence de traitement de surface

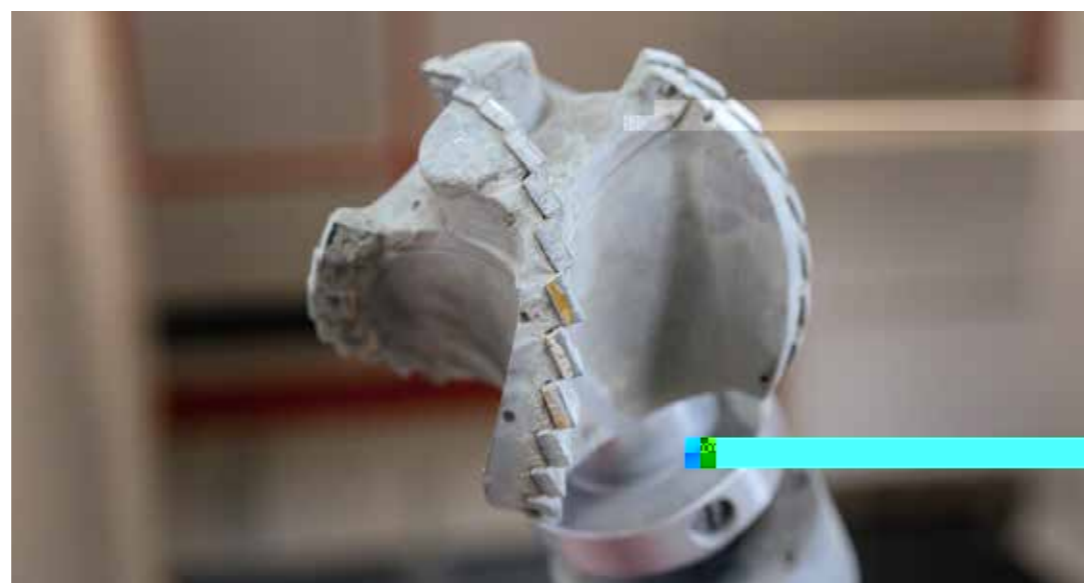
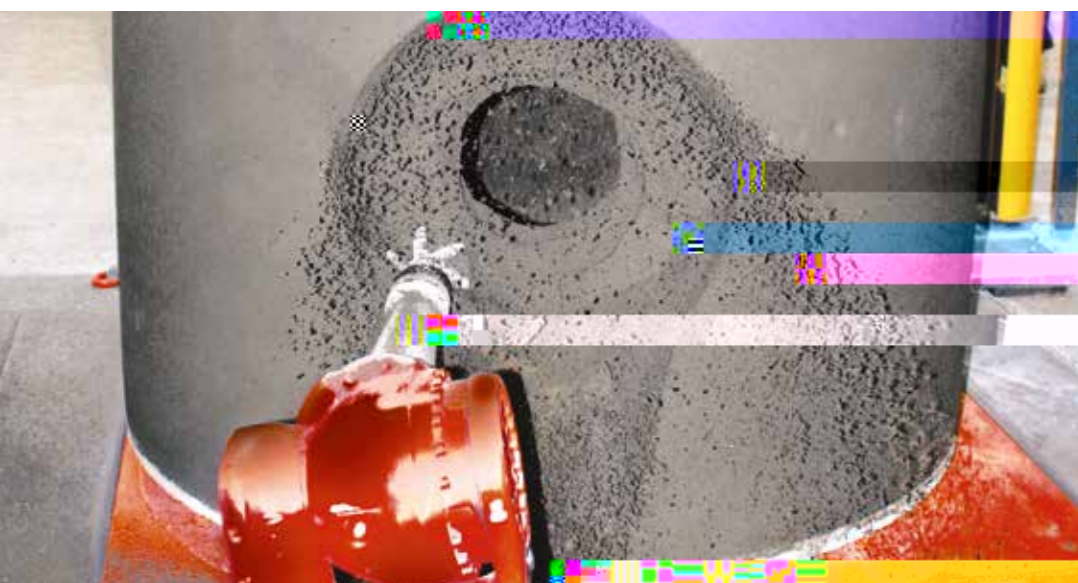
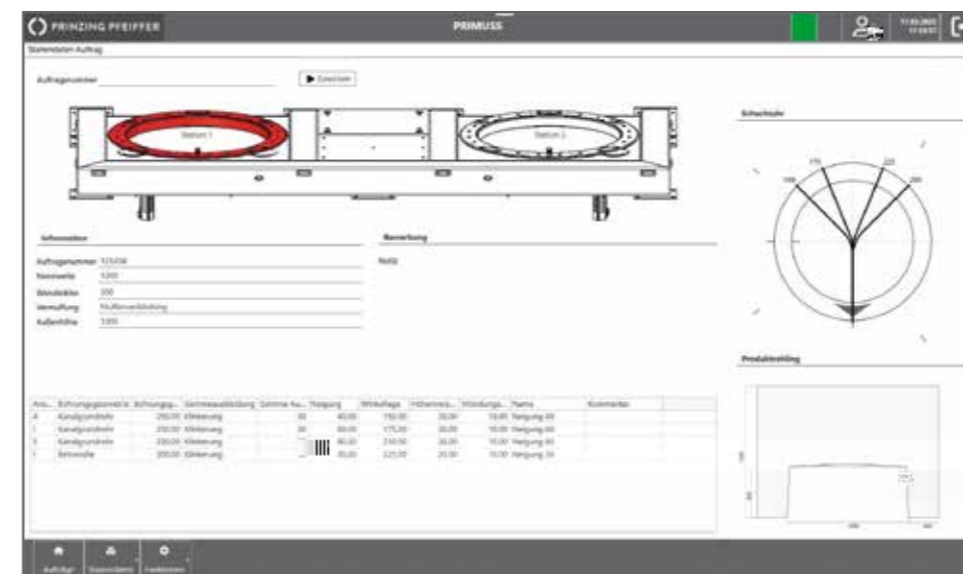
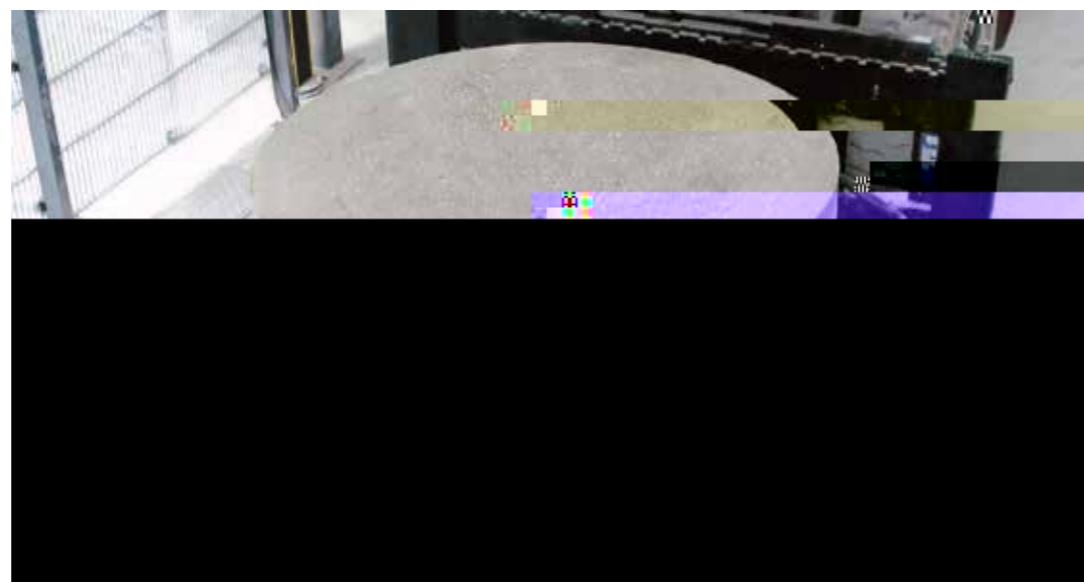

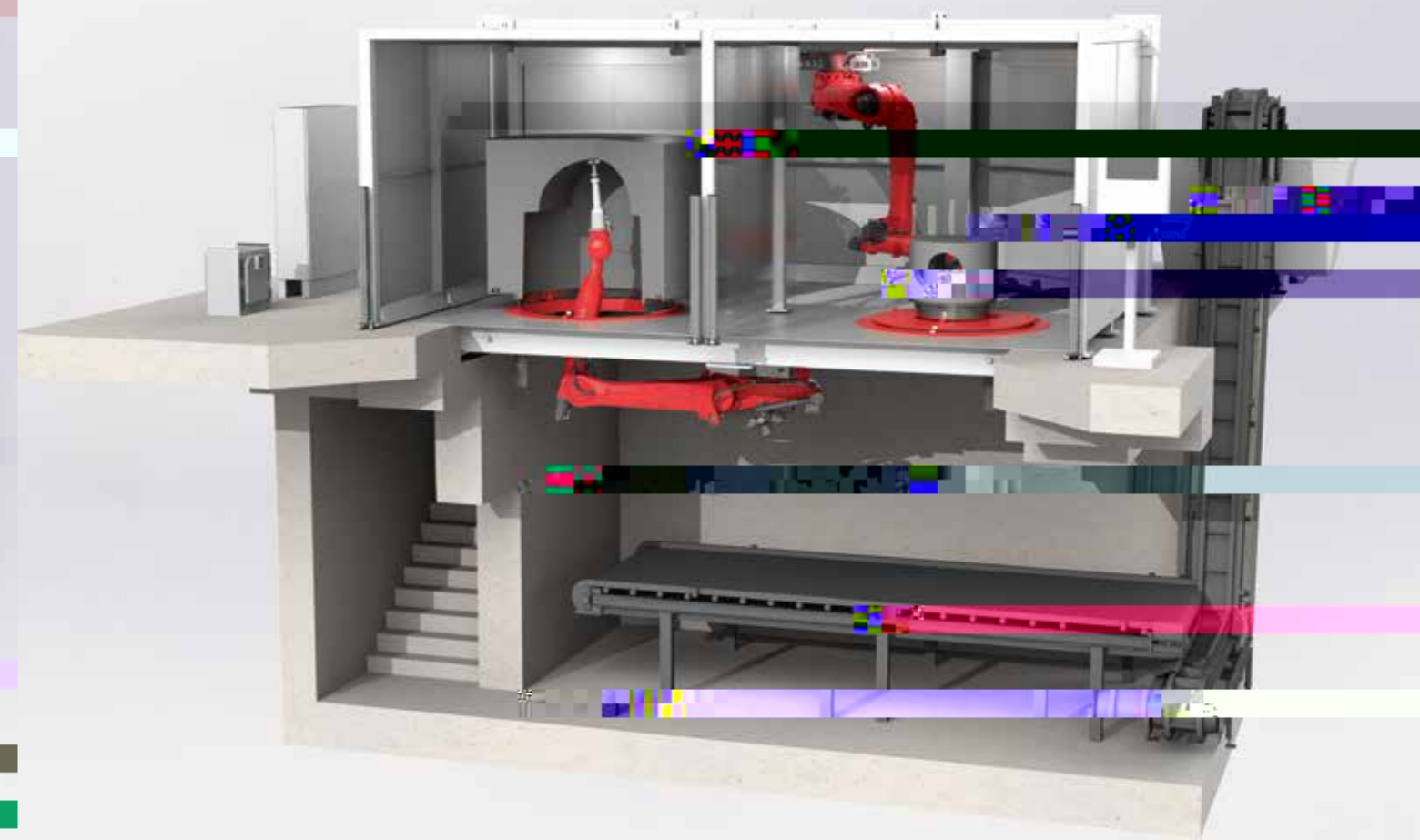
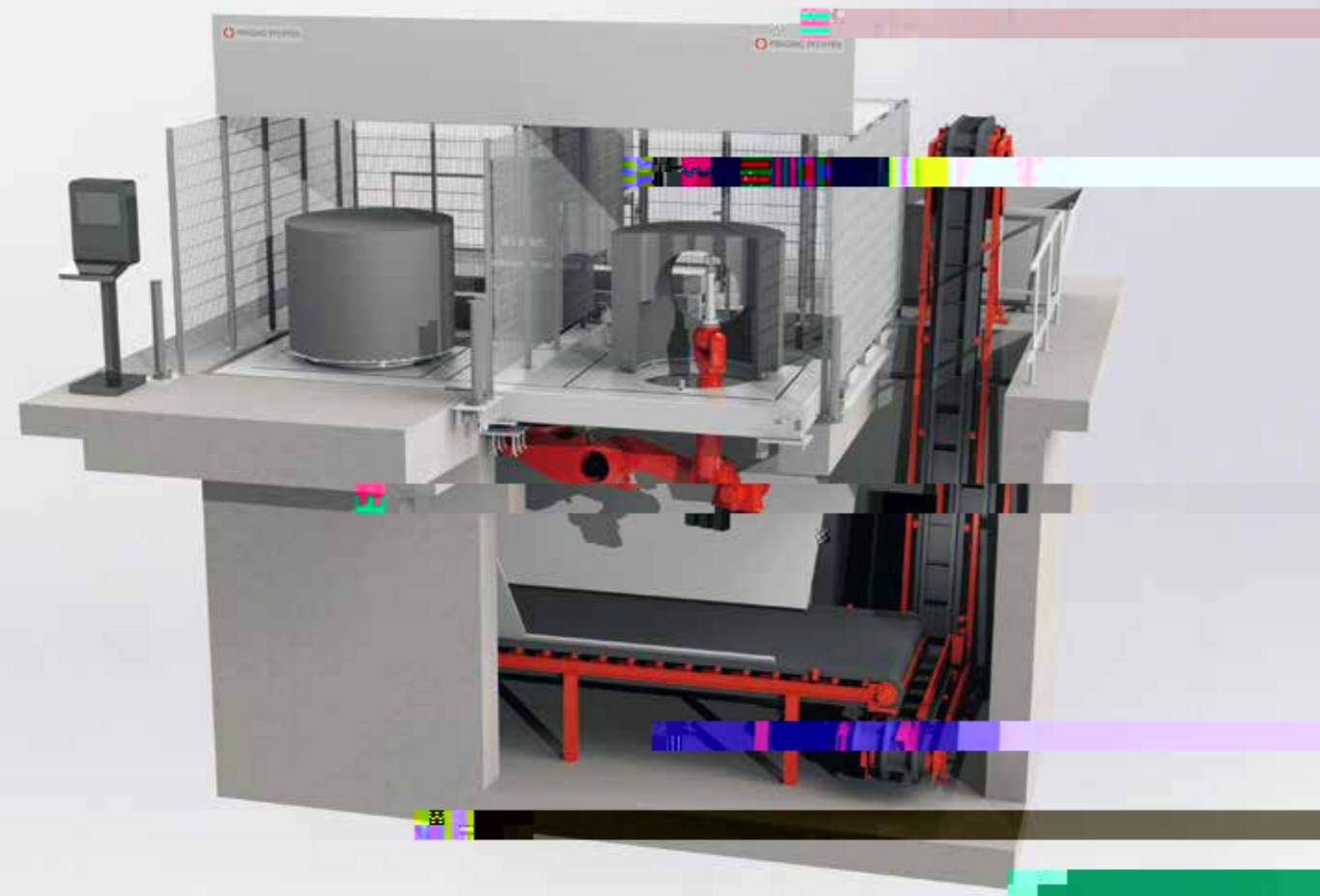

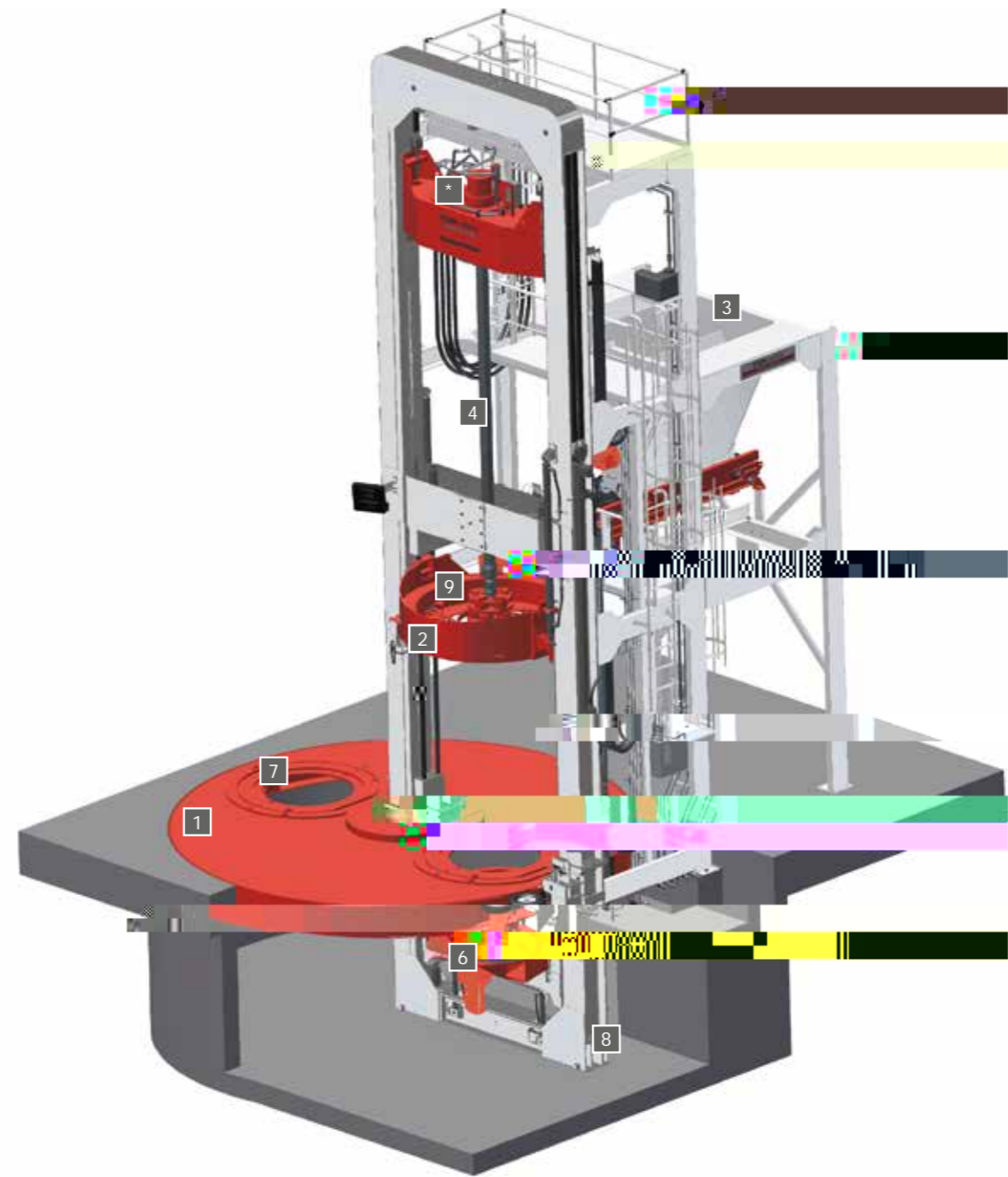

- B dY^ XVI ^dc kVgWwZ YZ`a`ad\j Zj gYZ`Xdchig Xi`dc` grâce à une table de travail réglable en hauteur
- Système de changement rapide QCs pour un chan-\Zb Zci hZb ^Vj idb Vi fj Z`YZ`Y`vb i g`cdb `cVa
- B dci Z`Xj Vg,Z`VkZXVZccZ` W idc!`eVgZnZb eā`Zc` cas de faible hauteur de transfert du béton
- 9`hedh↑{`Vj idb Vi fj Z`YZ`XZci g\A`YZh`XA`Zh` d'armature
- ; WgXVi`dc`VkZX`b dj āzh`Zni gZj gh`Zc`igt`h`eVg`Zh` en cas de hauteur sous plafond réduite
- Intégration à des systèmes modulaires de manu-izci`dc`YZ`ij nVj nZi`YZ`gicYZaZh`YZ`VWhZ
- 9Vi`6cVanoZgZi`g`edg`c``edj gā` mise à disposition de toutes les Ydcc Zh`Zi`hi`Vi`hi`fj`Zh`YZ



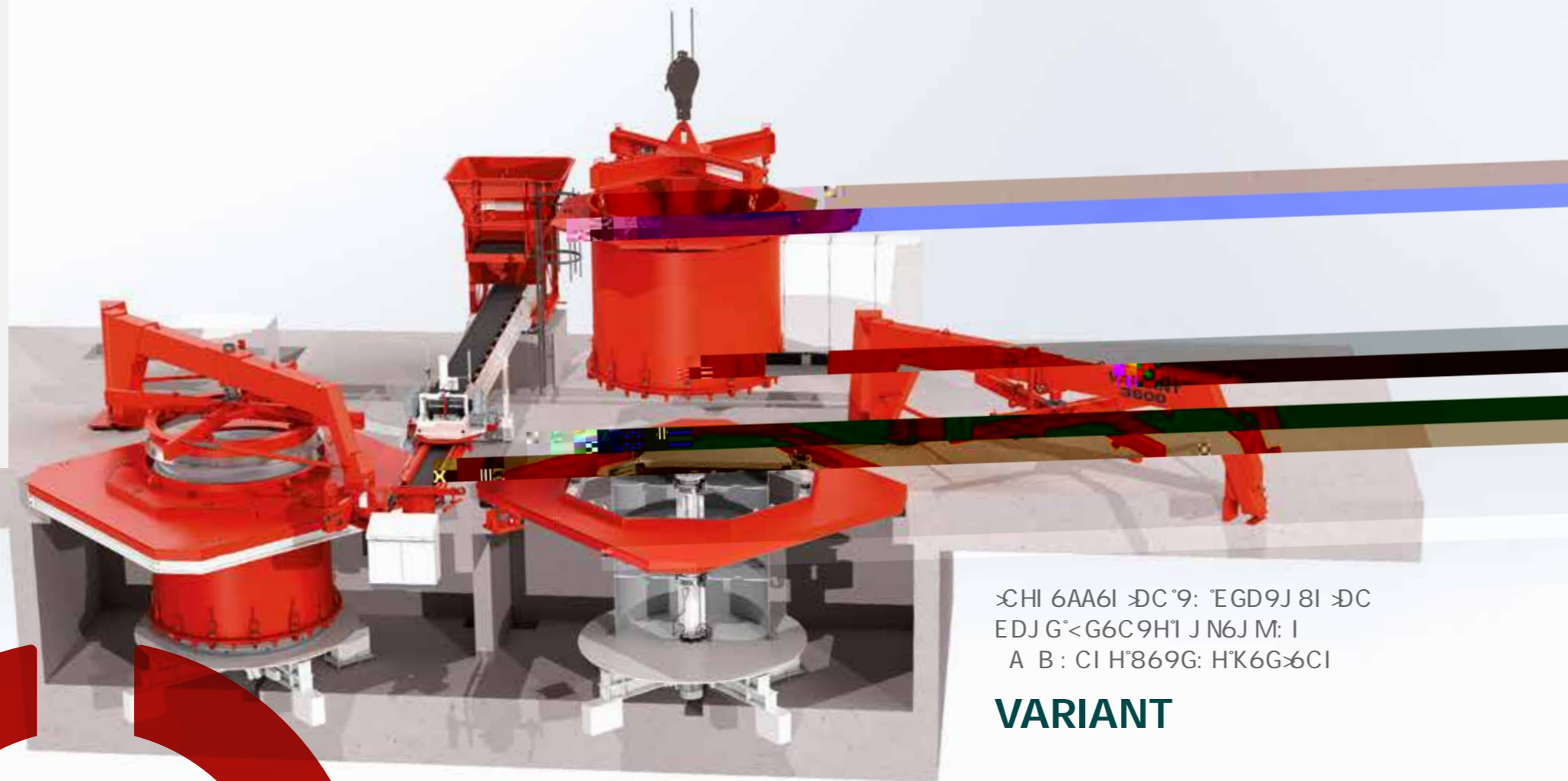

3000
 3000
 3000

VARIANT

AVK6G-6CI Zhi j cZb VX] cZ` ZmVZi VVeiVWZ!XVeWZ
 de produire une large gamme de produits en béton et en
 Widc`Vp #HZh`he X^XVi`dch`iZX] c`fj Zhi`hV`XVeVX↑`
 YVVeivi`dc`Zi`hdc`Z` XVX↑` Zc`[dci`j`c`X] d`mYZ`eZb` Zg
 ordre pour les fabricants souhaitant optimiser et déve-
 lopper leurs processus de production. Avec une vision
 Vm`Z`hj`gá`Yj`gV`Zi``z`h``kdj`i`dch`ij`ij`g`h`á`K6G-6CI
 représente un investissement rentable à long terme.

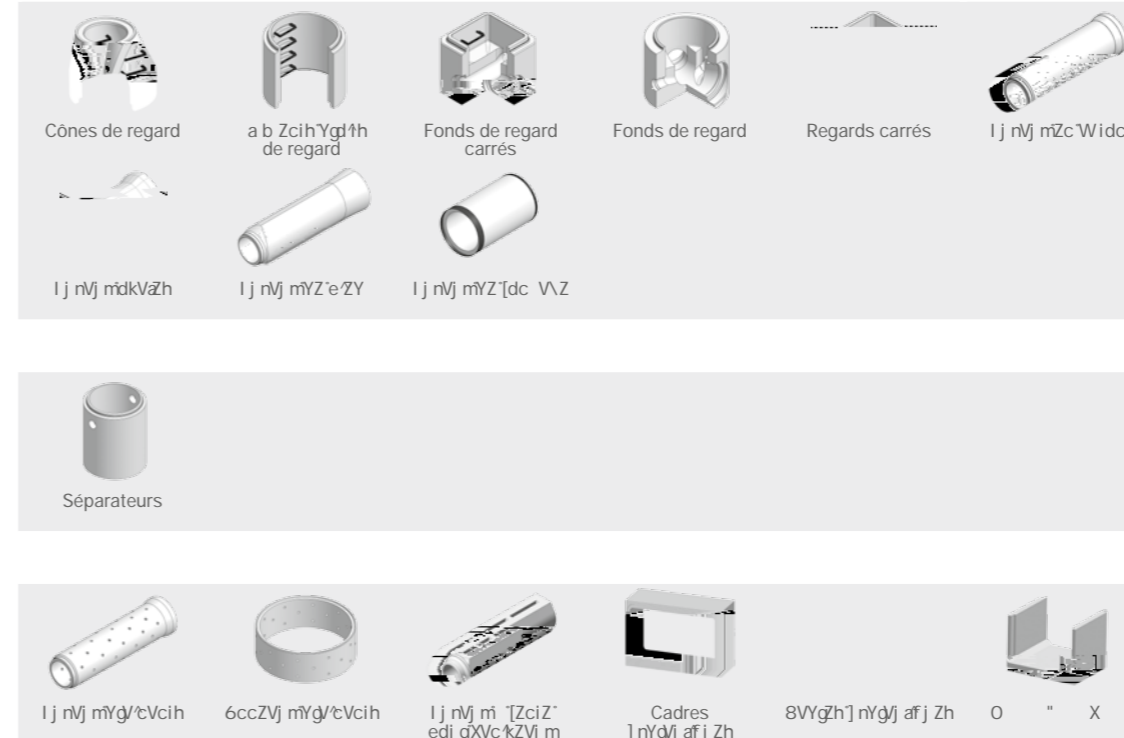

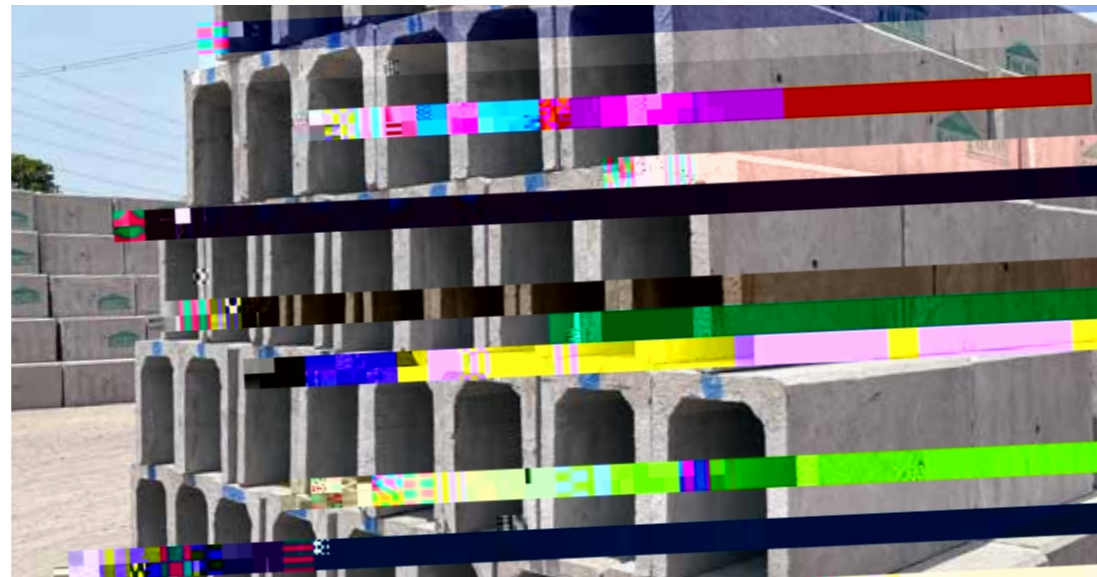
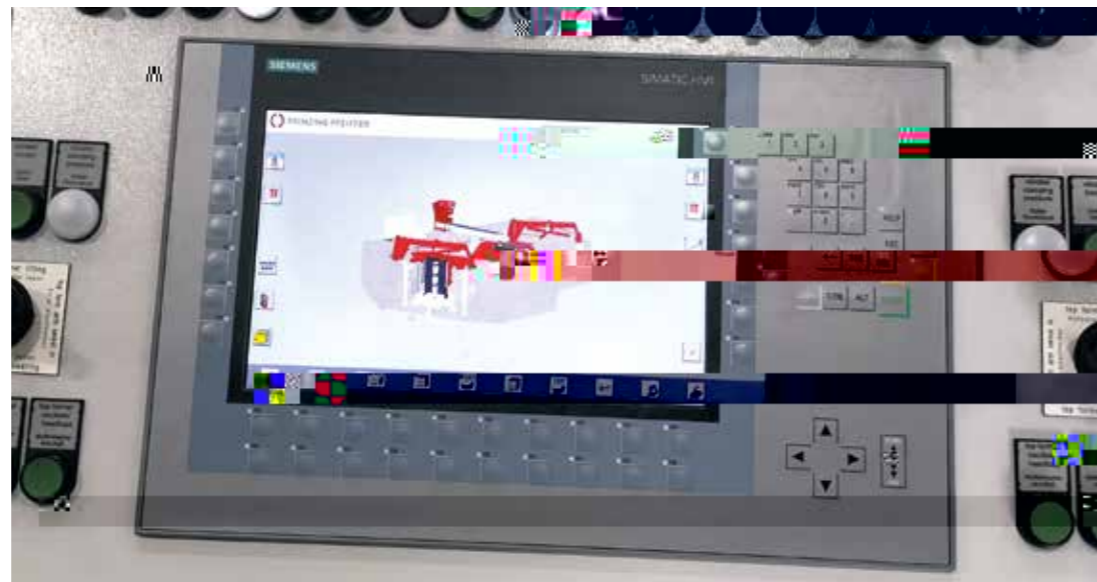

- Contrôle de contour pour la fabrication de produits cdc X'g'j d'g'h'i'Za'h'f'j Z'X'V'g'h' n'Y'g'j af j Zh' ij n'V'j m' 'eg' d' a'Zc'®'j [!'eg' d' h'Zc'J!'ZiX#
- Cadres porteurs réglables et composants b d'Y'j d'g'h'i'Za'h'f'j Z'b dj a'h'Z'n' g'Z'j g'h'Z'i'g'lc'Y'a'h' Y'Z'W'h'Z'edj g'a'eg'd'Y'j Xi' 'dc'_ Zh' n'Y' V'j af j Xi'



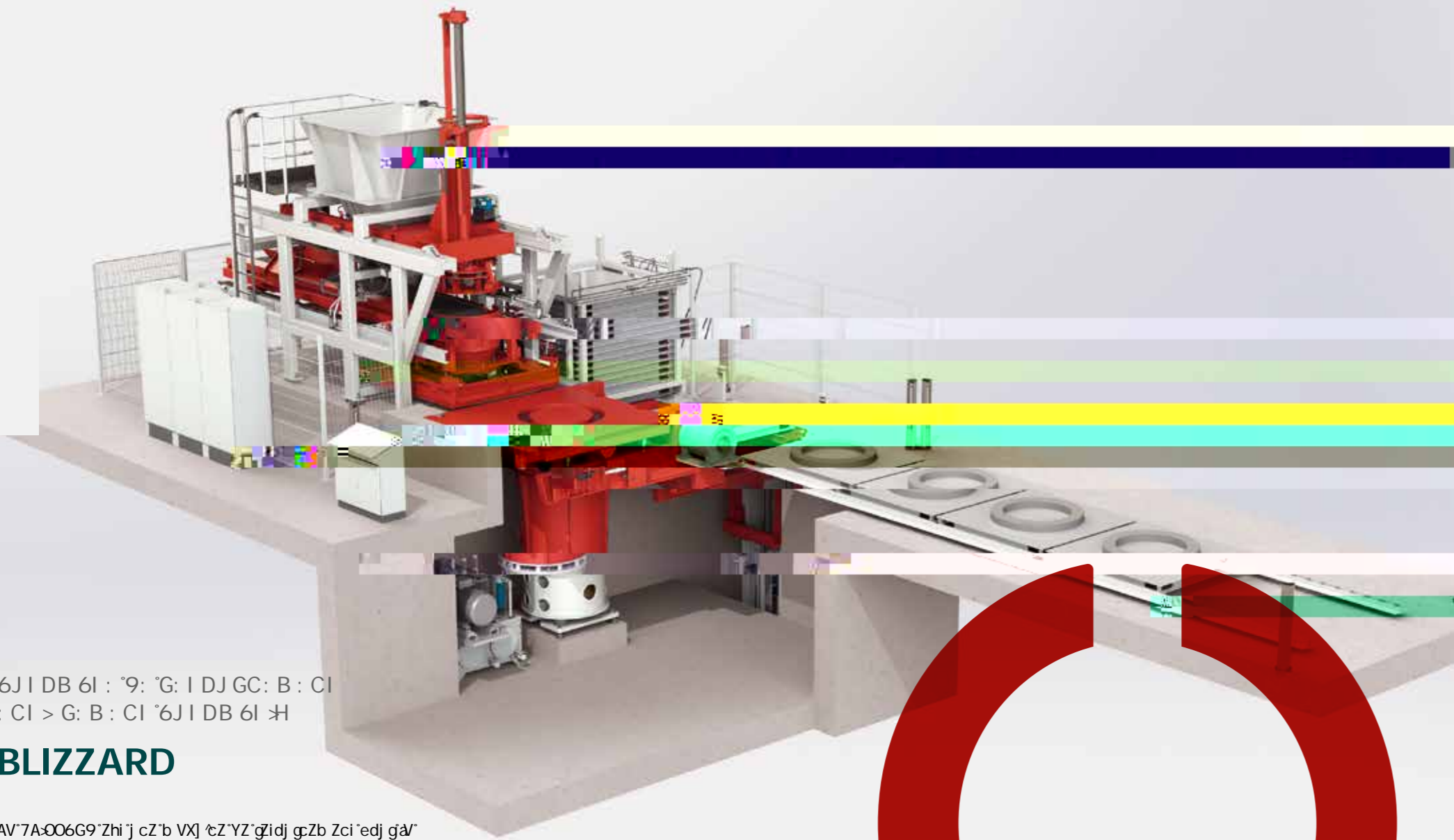

6J I DB 6I : °9: °G: I DJ GC: B : CI
 : CI > G: B: CI °6J I DB 6I ㄐ

BLIZZARD

AV°7A-006G9°Zhi°j cZ°b VX] °Z°YZ°g°idj °Zb Zci°edj g°V°
 fabrication stationnaire de produits les plus divers. Le
 eg°X Y °YZ°g°idj °Zb Zci°eZp Zi°YZ°[V°W°f°j Zg°YZh°eg°l-
 Yj °h°V°j idb Vi°f°j Zb Zci Zi° °b d°e°Y°g°°Xd i#

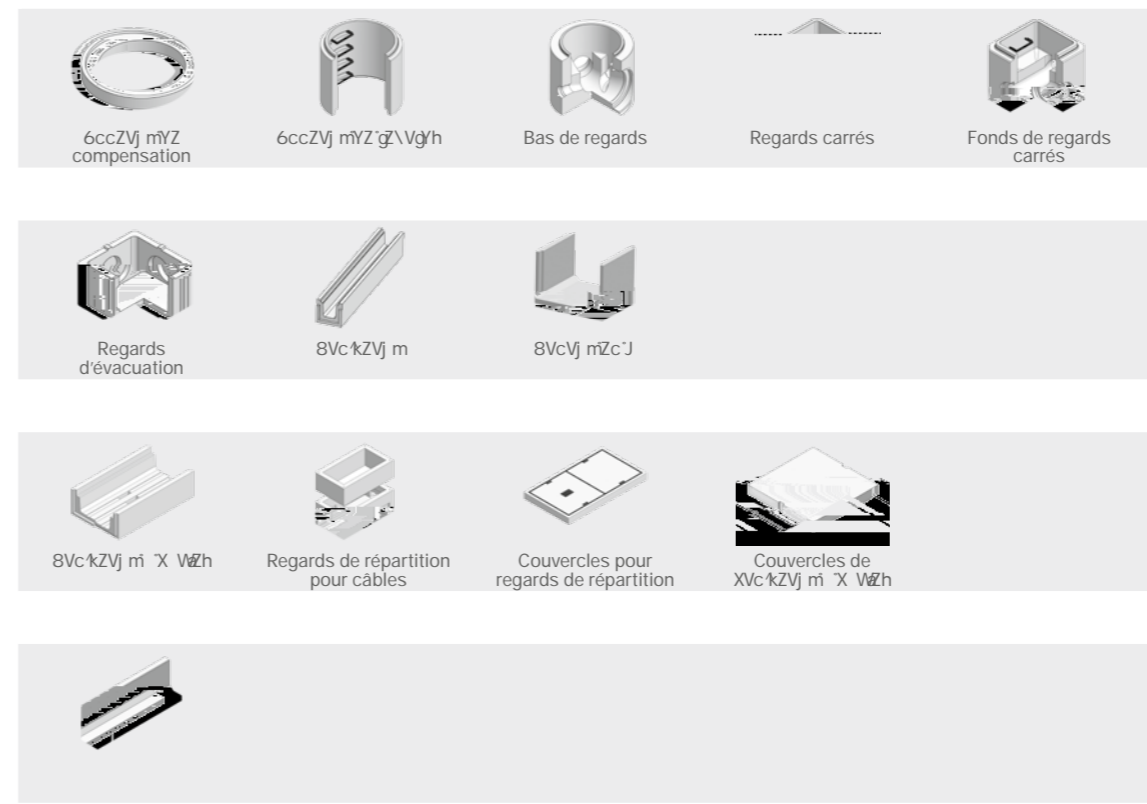



- Système de manutention entièrement automatisé
- K... g... m... g... a... Z...
- 6... V... i... Z... c... Z... b... d... Z' pour réduire l'adhérence du béton au moule
- Station de nettoyage pour le nettoyage des palettes en acier
- 6... V... i... Z... c... Z... b... d... Z sur les palettes en acier
- 9... V... c... Z... g... e... g... a... b... h... Y... h... c... Z... i... Z... h... h... i... h... i... f... Z... de production pertinentes
- 9... h... h... h... b... V... i... Z... Z... changement de moule
- 8... W... Z... V... X... d... i... f... j... Z... e... d... j... g... a... g... Y... j... X... i... c... du bruit ambiant
- Smart Check pour un contrôle régulier et professionnel de votre installation



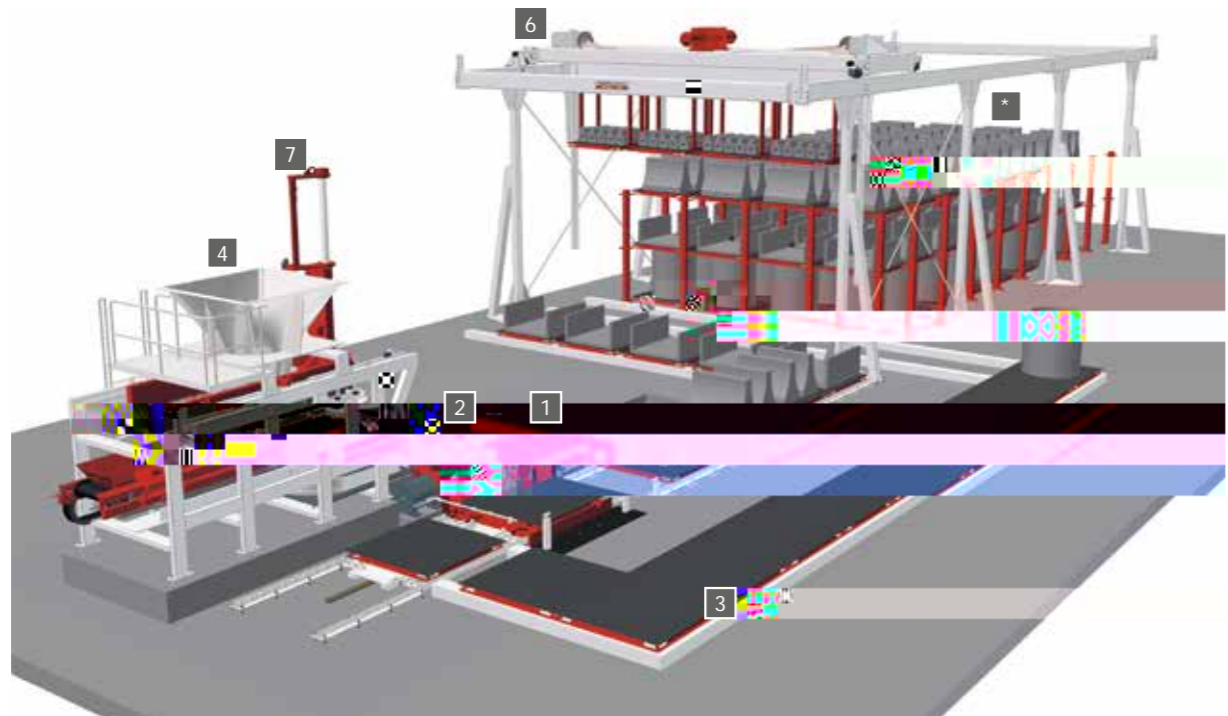

- 1 9'hedh↑↑'YZ'g'zidj g'Zb Zci'YZ'b dj ā
- 2 f'j 'eZb Zci'YZ'b dj āΛZ
- 3 G'Zidj g'Vj idb Vi f'j Z'YZh'eVāiizh
- 4 Installation d'alimentation en béton
- * Rayonnage de durcissement
- 6 GdWāi 'edg' f'j Z
- 7 Chariot de passage

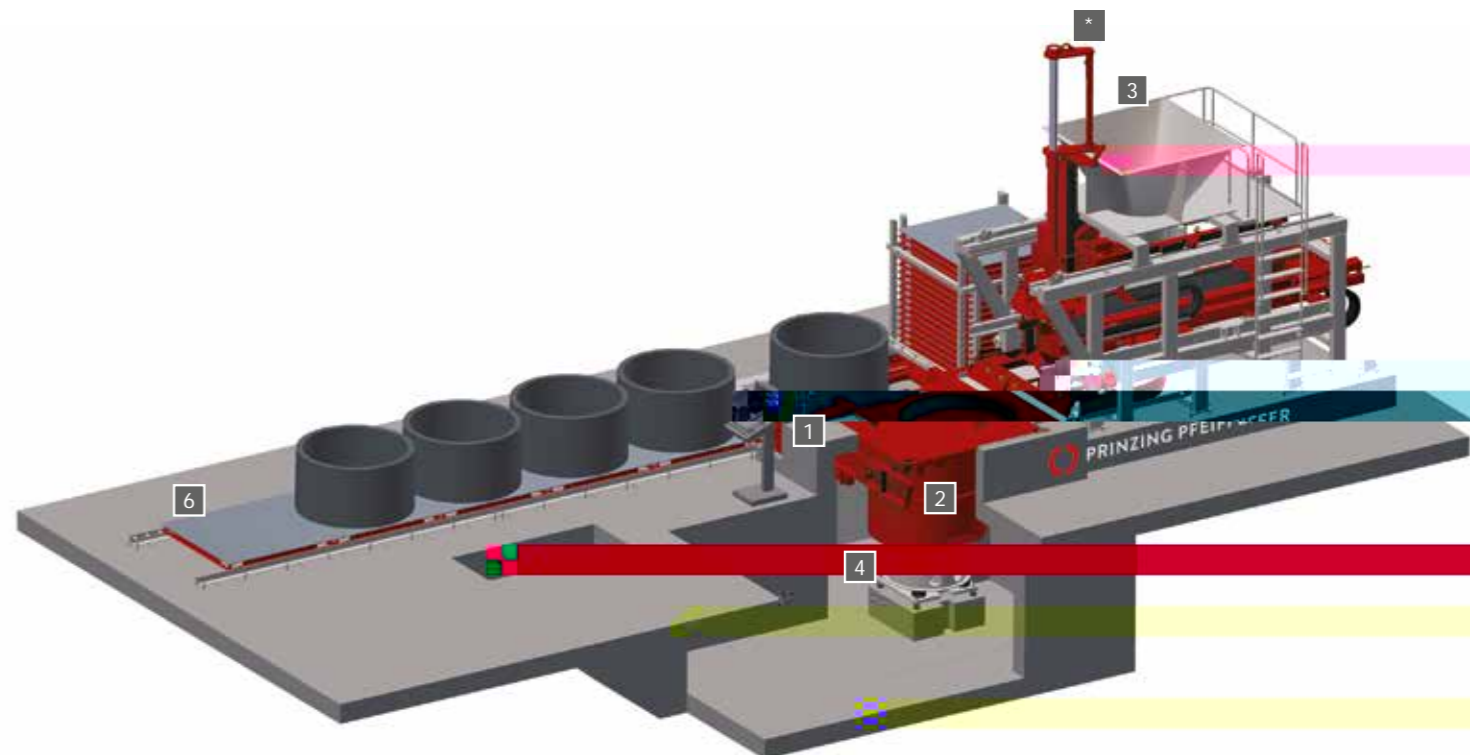

- 1 9'hedh↑↑'YZ'g'zidj g'Zb Zci'YZ'b dj ā
- 2 9'hedh↑↑'YZ'b dj āΛZ
- 3 Installation de chargement
- 4 Vibreur vertical
- * Chariot de presse
- 6 Convoyeur de dépose

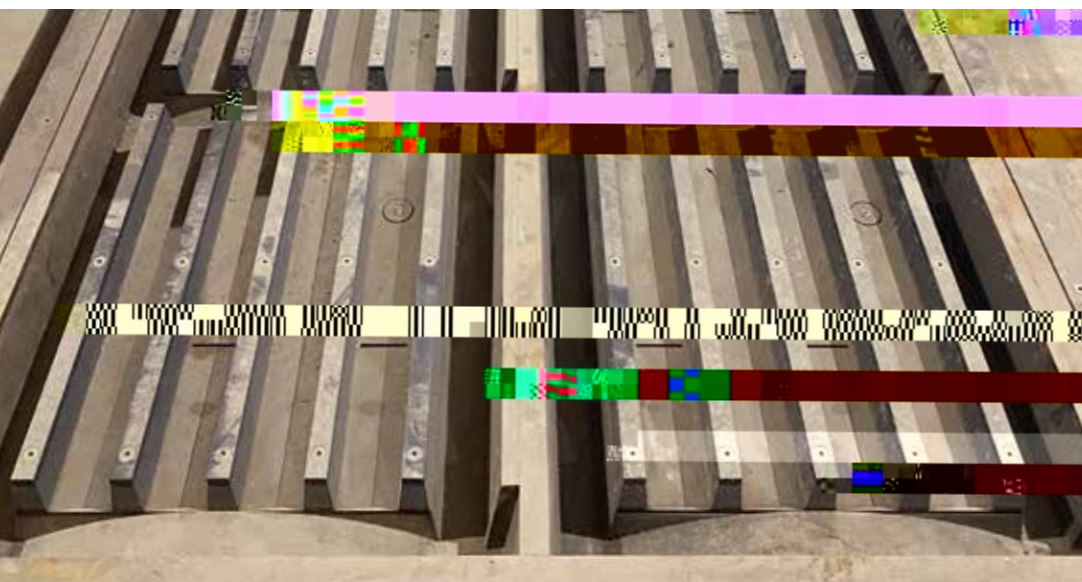
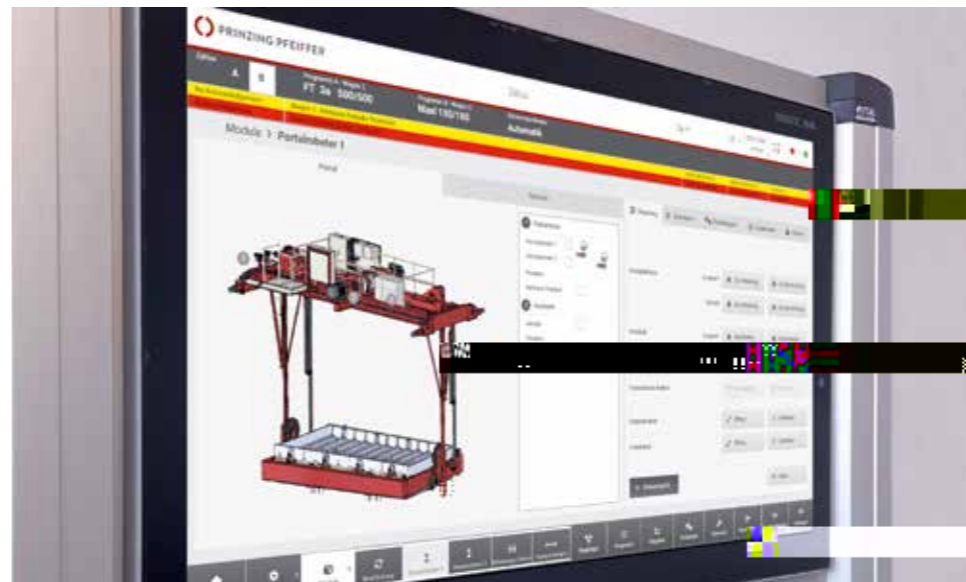

■ 9'hedh1[YZ'anhVZ'edj gVb atg'gaf'j Vat 'YZ'a' surface du produit

	systemes		
Plage de fabrication) &%m&(%b b), %m(%b b	+%m(%b b
=Vj iZj gb Vmb VZ	' *%b b	180 mm	300 mm
Ed'Yh'b Vmb VaYj `egYj ↑	1000 kg	4000 kg	10000 kg
: mZchVZ`vkXYZh systemes de manutention	Oui		
Version SCC disponibler	Oui		



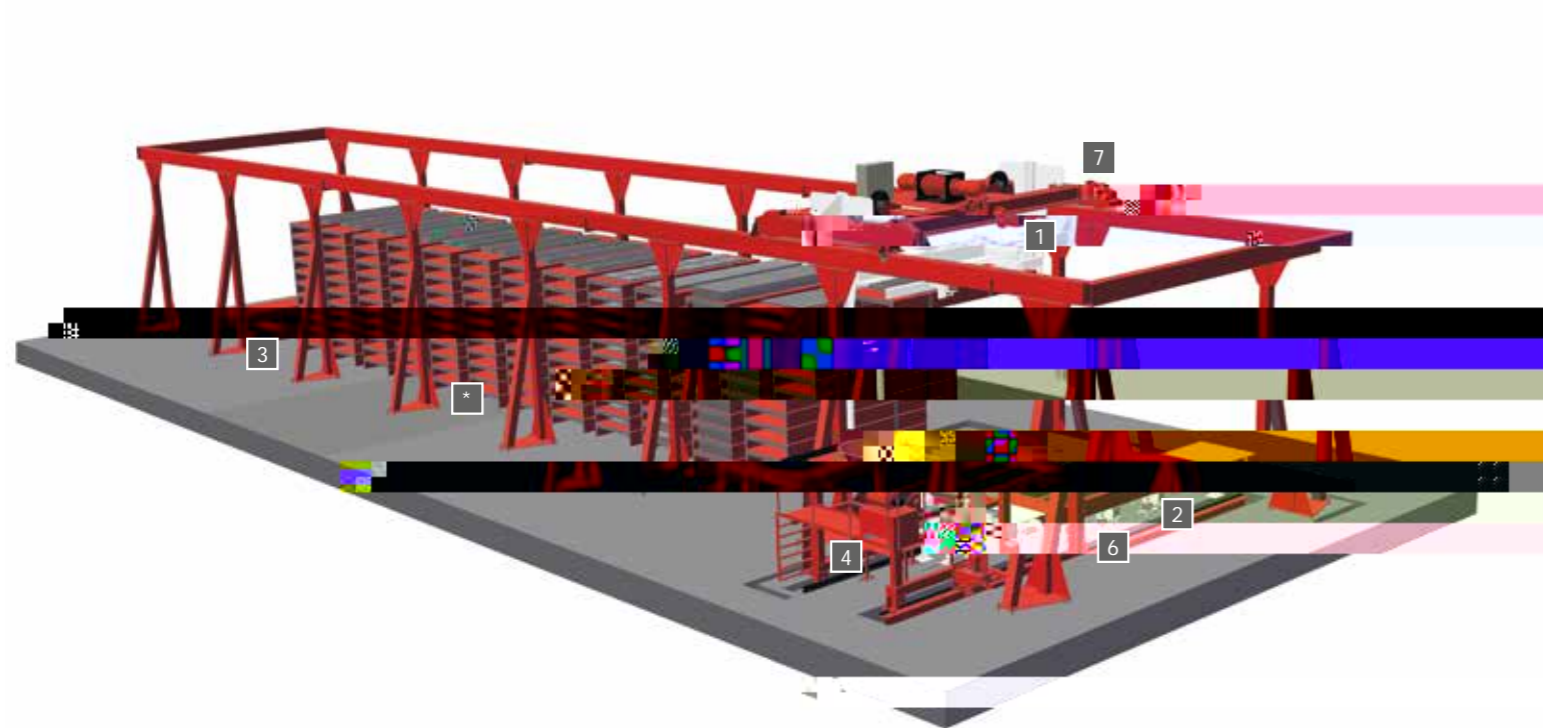

- 1 9'hedh↑↑'YZ'g'ij dj gZb Zci 'YZ'b dj ā
- 2 9'hedh↑↑'YZ'b dj āΛZ
- 3 Position de décoffrage
- 4 Installation de chargement
- * Pile de palettes
- 6 Vibreur vertical
- 7 GdWli 'edg f j Z

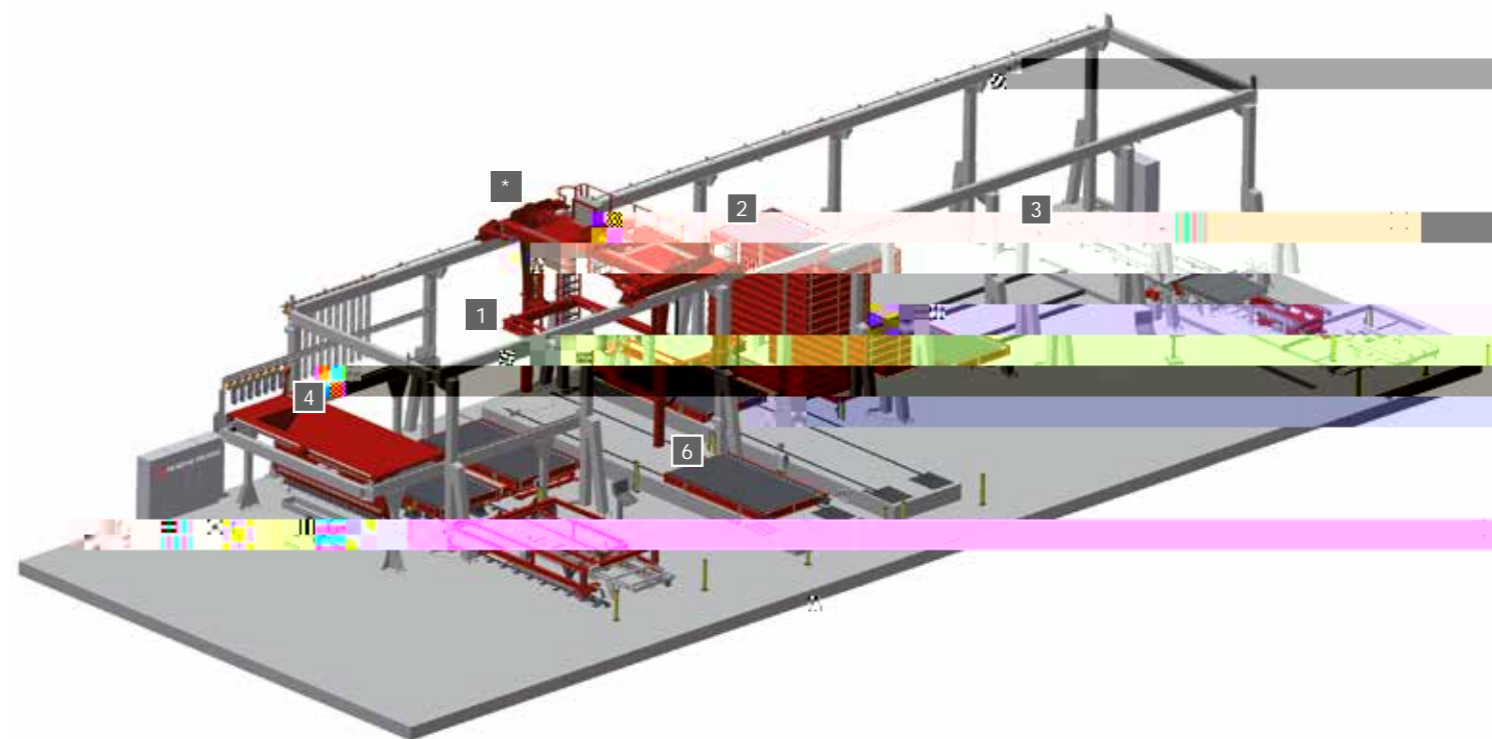

- 1 9'hedh↑↑'YZ'g'ij dj gZb Zci 'YZ'b dj ā
- 2 9'hedh↑↑'YZ'b dj āΛZ
- 3 Poste de décoffrage
- 4 Installation de chargement
- * GdWli 'edg f j Z
- 6 Poste de préparation

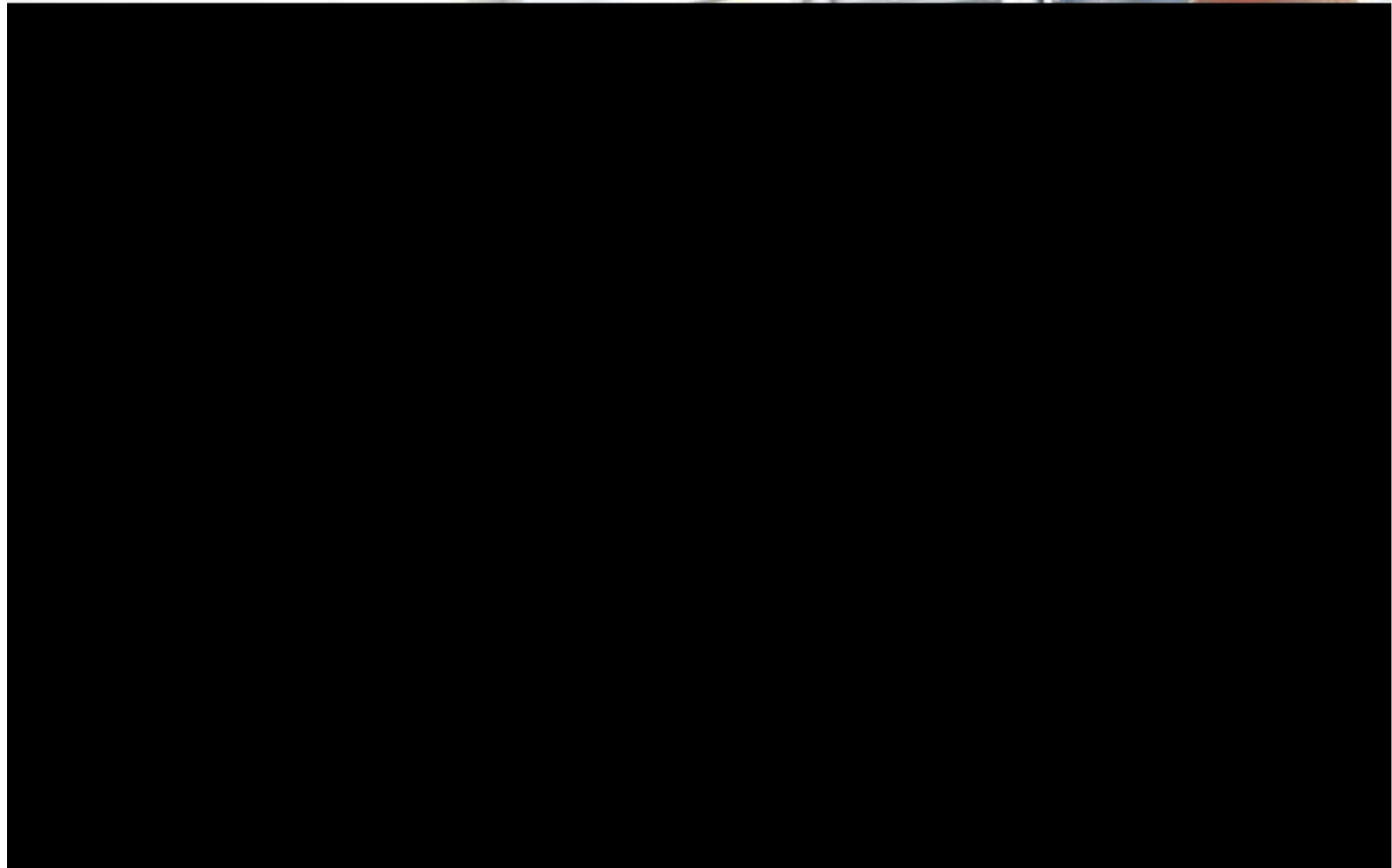

**DES SOLUTIONS
SUR MESURE D'UN
SEUL**



VOTRE AVANTAGE – MOULES ET CADRES

- Eaj hYZ'&+%VchYZne gZcXZ'YVch'zY kZadeeZb Zci!'a'XdcXZei 'tc' et la fabrication de moules et de circuits en béton pour la production Y' a b Zci'h'eg [Ww]fj h'Zc'Widc'edj gZ'Xdj aAZ'Zi'zY b dj aAZ' immédiat avec des mélanges de béton à consistance de terre humide.
- : nXZaZciZ'XdccV'hVcXZ'Yj b VgXj Zi'atcVj Z'Zne gZcXZ#
- 6kZX'eaj hYZ'(%Xda/Wdg/IZj gh'WZc'[dgh h'cdj h'hdb b Zh] c' eVgZcV'g'Xdb e iZci'edj gZ'h'g/cYh'b dj z'h'Zm\ZVcih'i'z'h'b dj z'h' he X'Vj mZi'z'h'Y'hedh'f'h'edj g'a'c'Yj higZ'YZ'a'[Ww]Xvi 'dc'Yj 'Widc#
- Possibilité de concevoir et de construire des moules pour YZh'b VX] cZ'h'YZ'i'Zgh'Zc'iZcVci'Xdb eiZ'YZh'XVg'Xi ghi'f'j Zh he X'f'j Zh'YZh'eg'Yj 4h'i'Zgh'eVg'cdh'hd'ch#



VOTRE PLUS – MANUTENTION

- 8dcXZeI 'dc' b dYj a/ 'gZ' Zi 'ZniZch'WZ' ' kda'ci
- J i 'ahVi 'dc' j' c'kZghZaZ'edj gY'[[gZcih'ineZh'YZ' b' VX] 'cZh'Zi tailles de rondelles de base
- æi \gVi 'dc' YZ'Xdb edhVcih'Y'Vj idb Vi 'hVi 'dc' YZ'] Vj iZ'f'j Vat
- H f'j ZcXZ'YZ'[dcXi 'd'ccZb Zci 'ad\ f'j Zb Zci 'eZch' Z
- Augmentation de la productivité
- Réduction de l'usure
- Système intégré de diagnostic des erreurs
- Réduction des besoins en personnel
- Amélioration des conditions de travail

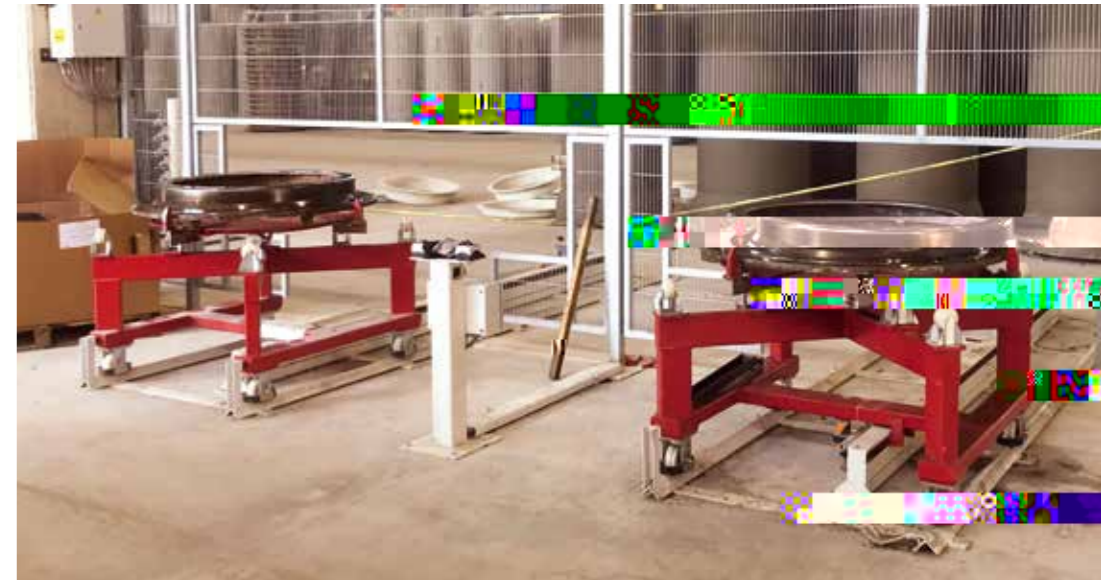
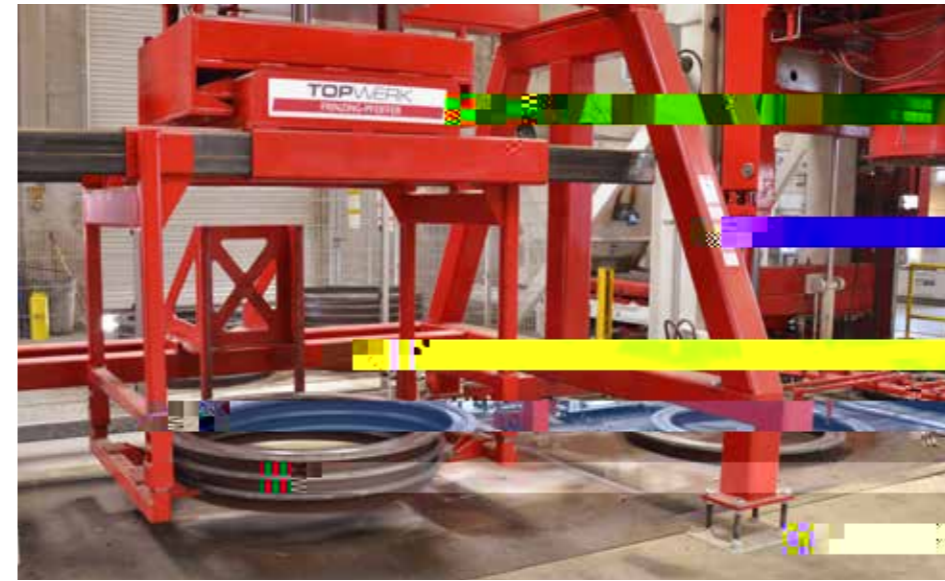

6 c'Ydei' b' hZg'āh'egd'XZhhj' h'YZ' egd'Yj' Xi' 'dc' 'Vj' hh'WZc' 'hj' g'YZh' 'chi'Va' / i' 'dch'c'Zj' kZh'f'j' Z'hj' g'YZh' 'chi'Va' / i' 'dch'Z'mhi'Vci'Zh'YZ' [W'g'XVi' 'dc' YZ' 'ij' nVj' m' dj' Y' a' b' Zci'h'Ygd' 'h'YZ' g'V'g'!EG-C'O<E; : : : G'eg'led'h'Z'YZ'h'hrhi' b' Zh' YZ' b' Vcj' i'Zci' 'dc' b' d'Yj' a/ 'gZ' h'Zi' ZniZch'WZ' h' kda'ci' 'edj' g'g'ic'YZa'zh'YZ'VW'h' Zi' 'e'Vā'ii'Zh'#J' i' 'ah'WZ'h'YZ' b' Vc' ^ g' 'Vj' id'c'db' Z'Zc' i'Vci' f'j' Z'hd'ā' i' 'dc' 'nda' Z' dj' 'ci' \g'WZ'h'YV'ch'YZ'h' a'c'Zh'YZ' egd'Yj' Xi' 'dc' 'Xdb' ea' i'Z'h' 'XZ'h'hrhi' b' Zh' eZ'j' kZci' i' g'Z' VV'Vei' h' 'idj' i' b' db' Zci' 'Vj' m'VZhd' 'ch'he' X' ^ f'j' Zh'YZ'h'Xa'Zci'h' ad'gh'YZ' 'ā' 'e] Vh'Z'YZ' eā'c' ^ XVi' 'dc' Zi' YZ' Xdc'XZeI' 'dc' #

HZa'c' ā'h'VZhd' 'ch'Zi' 'ā' 'Xdc' \j' g'Vi' 'dc' 'Xj' d' h'Zi' h' m'od'c'Zh' eg'c'X'e'Vā'h' Vj' id' matisées sont intégrées dans le processus de manutention des rondelles. YZ' VW'hZ' /Y' iVX] Zb' Zci' h' e'Vg'Vi' 'dc' c'Zi' id'n'V'Zi'] j' ā'V'Zi' Zb' e' ā'V'Z'Y' hZb' - e' ā'V'Zi'] j' hf'j' ' a'ci'gd'Yj' Xi' 'dc' 'YV'ch' a'chi'Va' / i' 'dc' YZ' [W'g'XVi' 'dc' YZ' 'ij' nVj' m' ou de regards.

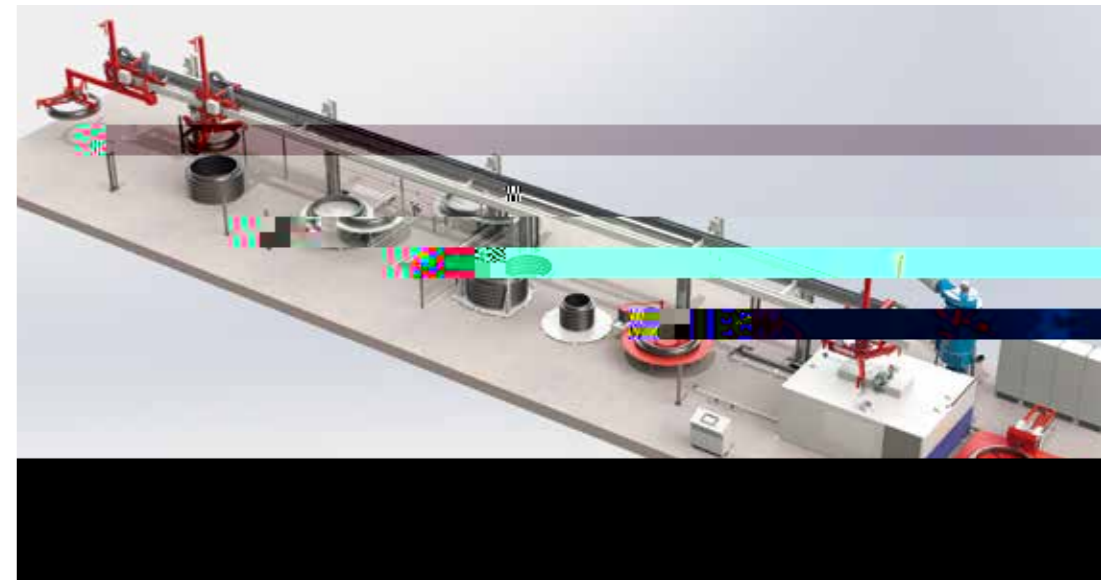
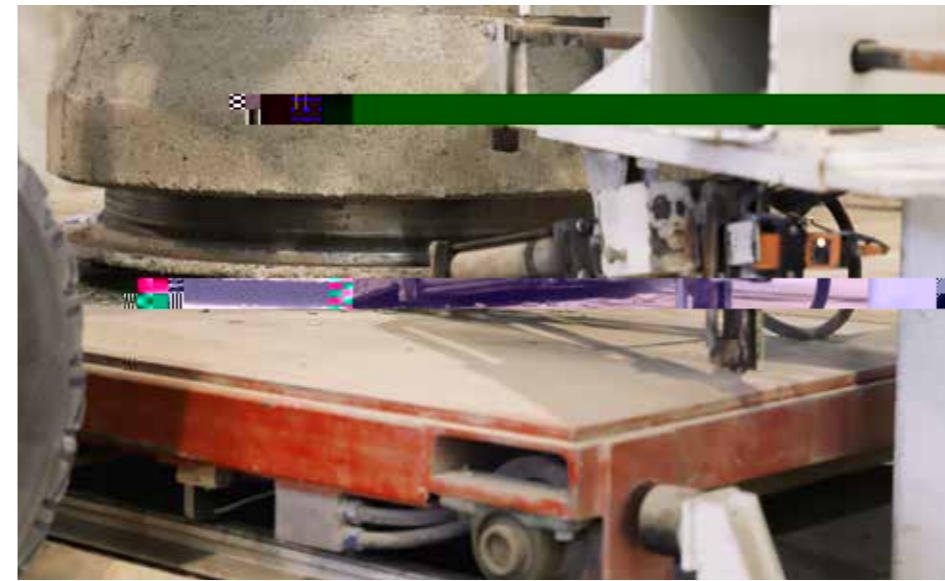
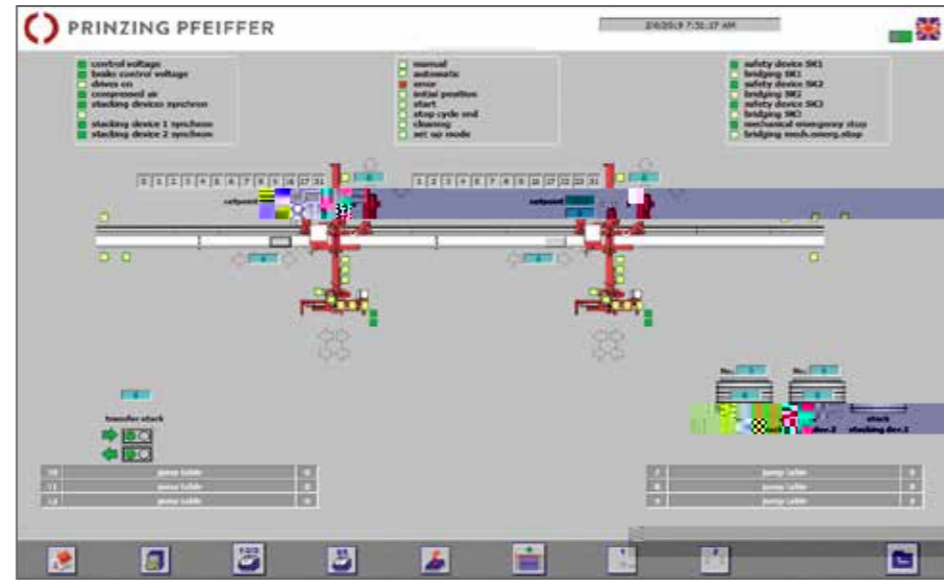

VOTRE AVANTAGE – SITES DE PRODUCTION ET D'ENTREPRISE

AV eaj eVg YZh b VX cZh edj gij nMj mZi g Vg h YZ k h t Z YZ aZci g eg hZ EG COC < E ; : > ; : G h dci [W y f j Zh Xdcig a Zh Zi ak g Zh h j g a h t Z VaZb Vc Y YZ Edg V L Zhi [VaXV tG] cVc Z Yj Cdg L Zhie] VaZi #AZh egL XZhhj h YZ [W y Xvi tci aZh XVeVX t h V ch f j Z aZh Y a h YZ ak g h dci Zi a l a l h i f j Z h dci dei b h h g XZ a h d a i t c ~ c] d j h Z #Cdh h t Zh g eg hZci h YVch a b dcYZ Zci Zg Zi a j g h idX h a l Xvj mYZ e ^ XZh YZ g X] Vc L V g ci h h Zci j c Z b h Z Zc @ j k g g e YZ YZh YZb Vc Y Zh YZh XaZci h he X f j Zh Vj mh t Zh YVch a Ydb V c Z Yj h Z g X Z Y Zh e ^ XZh YZ rechange et du service après-vente.

Hj g a Zh h t Zh VaZb Vc Yh YZ A b V y g V # Y #AV] c Zi YZ 7 a j W j g c i a h X d a l W d g i Z j g h YZ a c \ c Z g Z Zi YZ a l k Zci Z h Z [[d g Zci YZ g edc Y g V j m souhaits individuels des clients.

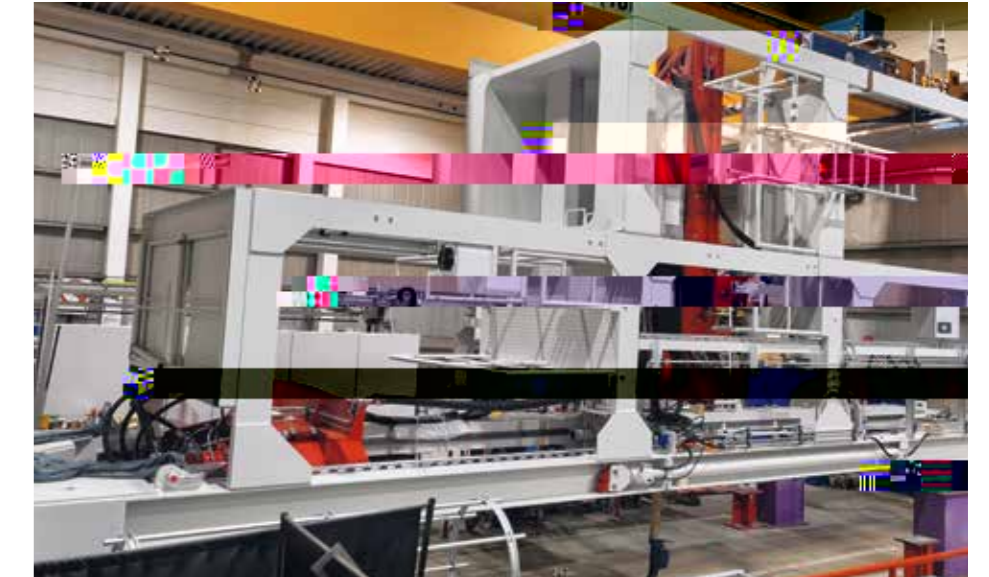

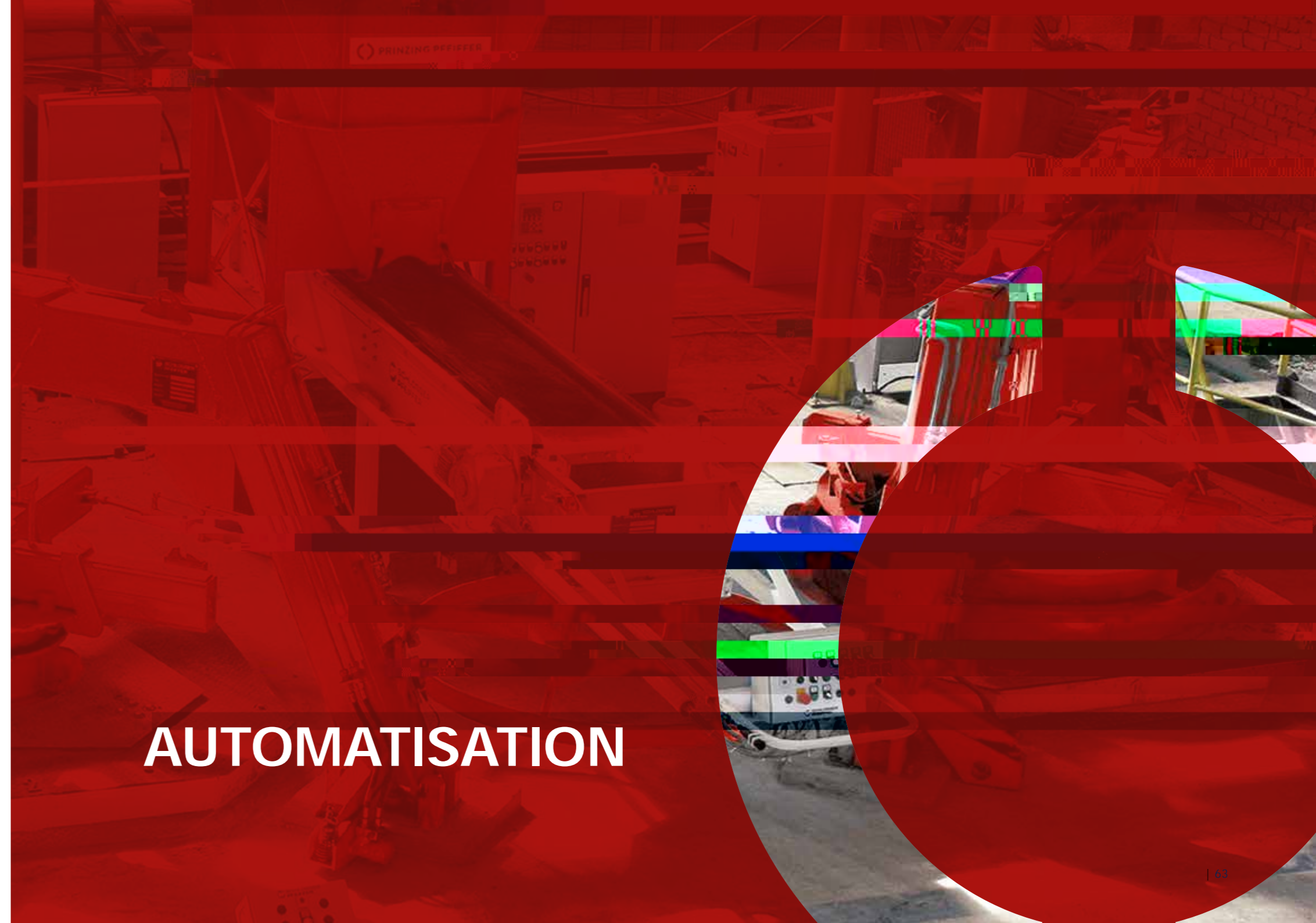

AUTOMATISATION

HI 6I HI ƆJ : H'9: °EGD9J 8I ƆC"
: C'1 : B EH'G : A: I °E6GI DJI °

DATA ANALYZER

ækZhi g'YVch'YZ'cdj kZaZh'iZX' cda\Zh'Zhi'idj_dj gh'j cZ'
Y b VgJ Z'Vp W'Zj hZ'i'b Vh' \Vz'b Zci'j cZ'k gf'Wz' de-
edgj c† #<g XZ' °cdh'hrhi b Zh'I ZWYZ'XdaZXiZ'Zi'YZ'
khj VahVi'dc'YZh'Ydcc Zh'YZh'VkVci\Zh'Xdch'Y g'Wz'h'
hd[[g'zi'Vj hh'Wz'c'Vj m[Wg'XVcih'YZ'egYj th'Zc'Widc'
eg [Wgf] °Y _ °iWah'fj Vj mVXiZj gh'°cdkVcih'YZ'YZ-
main.

F j Z'kdj h'VnZo'WZhd'c'YV X] Zgāzh'eZgdgh VcXZh'VXi j -
ZaZh'YZ'kdh'b VX] °Zh'hdj h'[dgh Z'YZ'iWz'Vj m'j YZ'\gh-
e] °f j Zh'YZ'Xdchj āZgZc'iZb eh'g Zāa i'V'YZ'[dcXi'dccZ-
b Zci'YZ'kdig' °chiVaVi'dc'egYj Xi'dc'Vgg i'ViiZiciZ'dj °
ZcXdg'YVXX YZg' ā] h'iddgf j ZX] g'cdad\ f j Z'Xdb eāi YZh'
[dcXi'dch'b VX] °cZ'i'dj iZh'XZh'Ydcc Zh'hdc'i'Yhedc'Wz'h'
°W'YZb VcYZ# aZh'eZj kZci' °ig'Xdchj ā Zh'Zcō\ h'ig Zh'
Zi'Znead† Zh' °idj i' b db Zci'hj g'YZh'VeVz' ah'b dWz'h'
iZh'f j Z'hb Vg'e] dcZh'iWz'iZhdj kvadg'vWz'g'oi'ng' #

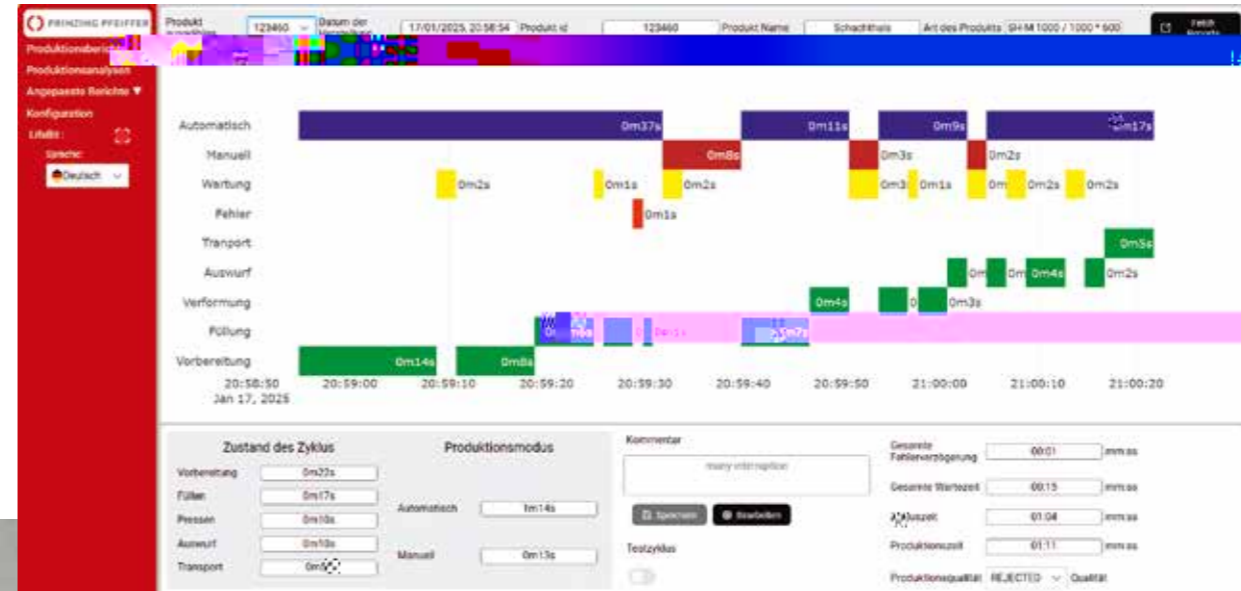
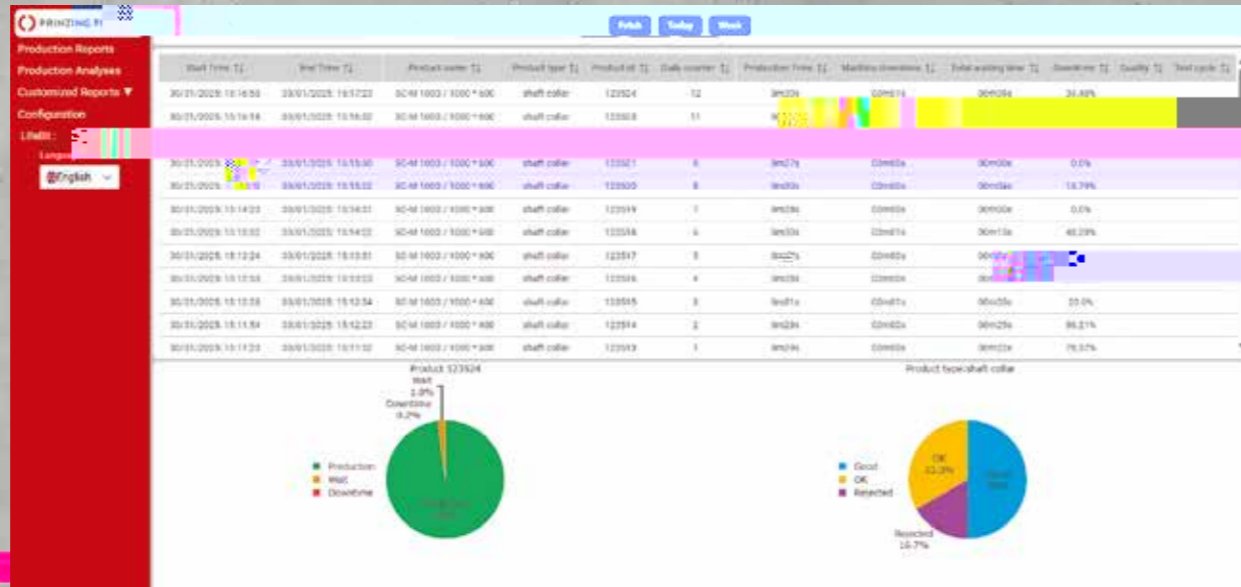

- Analyse des données API en temps réel
- 9 iZXiZ'i g' V\ °g'e'YZb Zci'Vj mZggj gh'Vj m' iZb eh'Y Vgg i Zi'Vj mg'z'Vg'h'YZ'egYj Xi'dc' Résumé de la production Enregistrement YZh'Ydcc Zh' °æc\iZgh Z'8dcccZm'c1 ZW sécurisée
- Connectivité possible avec plusieurs API
- 7Vh' hj gāZ1 ZWVXX h'YZej h'YZh'iZgh °Vj m' mobiles et des PC



AD< 8> A^9: °8DB B 6C9:
A: °8- JG^9: °8=6FJ: °XCHI 6AA6I >DC

NEXT BASE

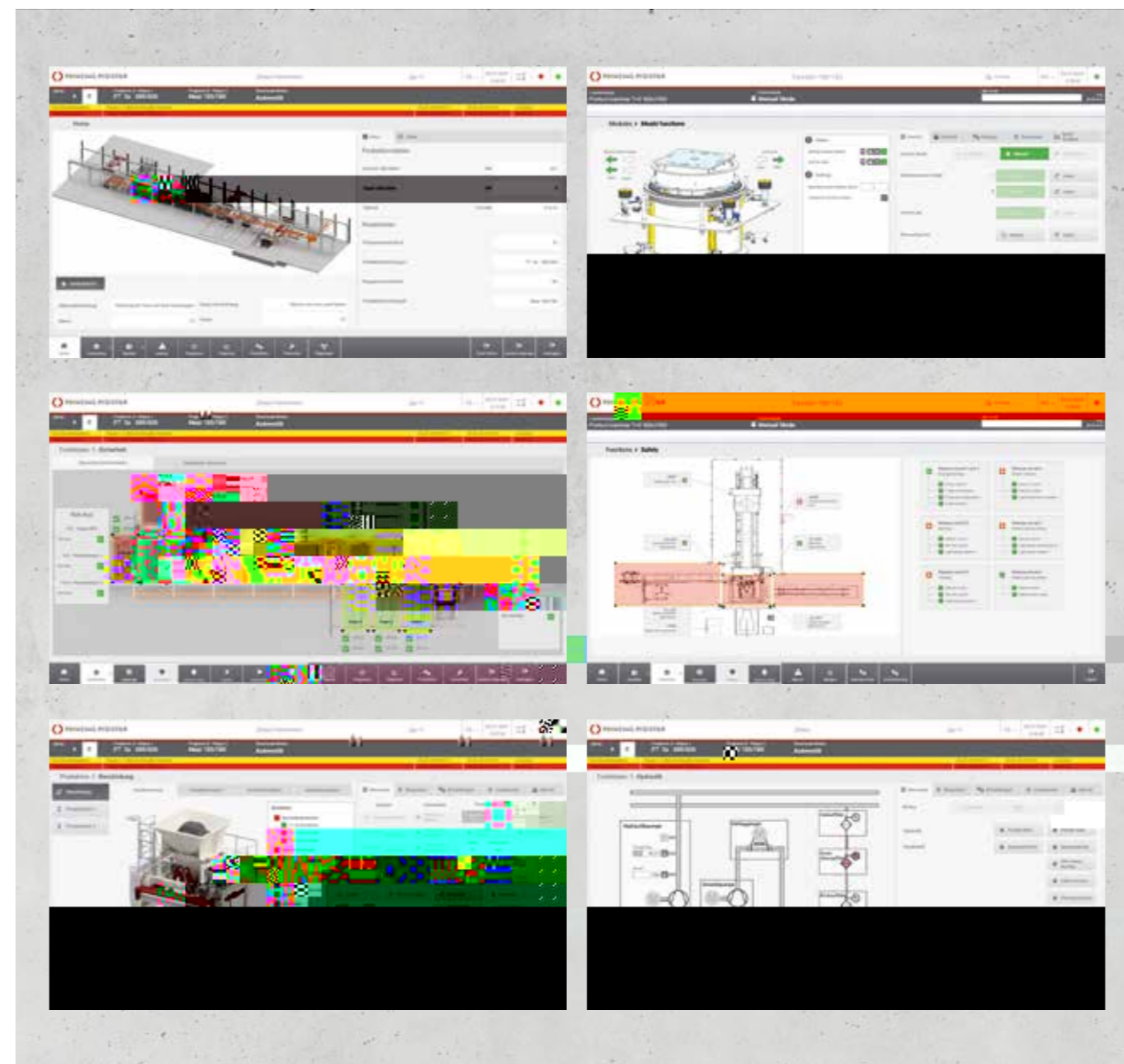



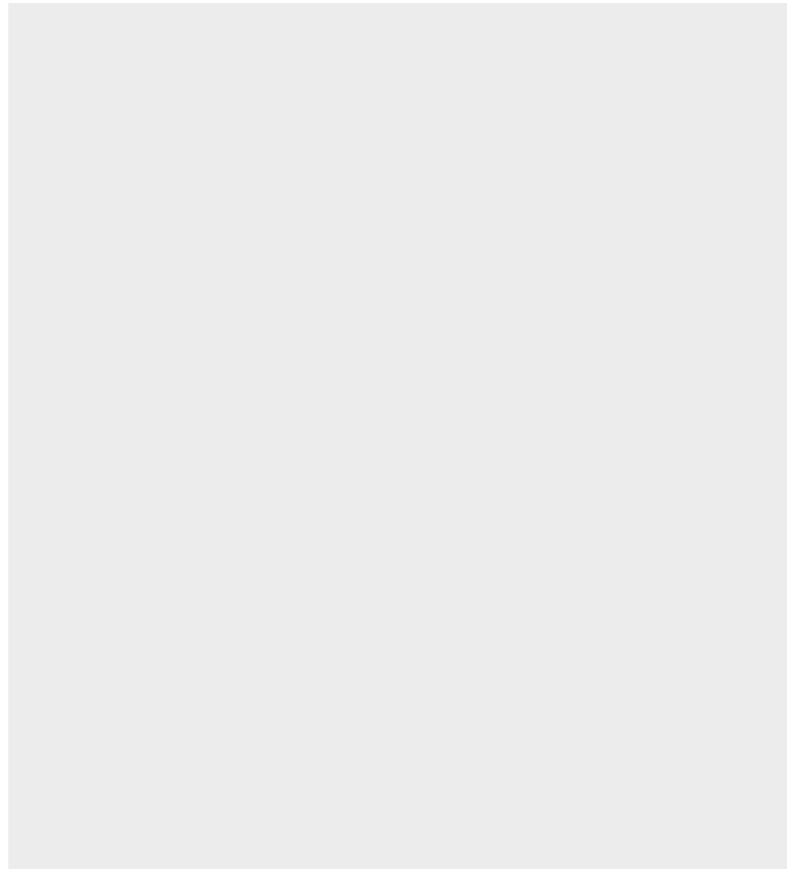

TOUT D'UN SEUL MANIPUL

Bon service après-vente et accompagnement continu. Que ce soit par des mises à niveau de votre parc de machines ou un suivi et des formations sur mesure directement chez vous. Notre expertise est reconnue par nos clients et nos partenaires. Nos services sont conçus pour vous offrir une expérience optimale et des solutions adaptées à vos besoins. Nos équipes sont formées et certifiées pour garantir la qualité et la sécurité de vos installations. Nous sommes à votre service pour vous accompagner tout au long de votre projet.



6J <B : CI : OKDHE : G; DGB 6C8: H

- Fourniture et intégration de systèmes de sécurité et de protection des travailleurs
- Bénéficier de l'expertise et de l'expérience de nos ingénieurs et techniciens
- Analyseur de données pour surveiller et optimiser les performances de production
- Bénéficier de l'expertise et de l'expérience de nos ingénieurs et techniciens



A*G6*HDC*G6E*9:

- Conseils complets et compétents pour l'ensemble de votre projet
- Les offres sont adaptées individuellement à vos besoins
- Pièces de rechange originales de haute qualité
- Service client dédié et réactif



- Démoulage immédiat et les produits en béton coulé
- Réparation et entretien des moules
- Bénéficier de l'expertise et de l'expérience de nos ingénieurs et techniciens



EDJ G*KDH*7: HD*EH

- Formation sur le service et la maintenance
- Optimisation des processus



KDI G: *8DCI 68I : J G PERSONNEL

- Services à long terme
- Assistance en ligne

NOTRE
ÉQUIPE DE VENTE



9'gZiZj g\ c g/a



9'gZiZj gXdb b Zg'Va



9'gZiZj gg \ 'dcVa
des ventes



Responsable régional
commercial



Responsable régional
commercial



Responsable régional
commercial



Chef du service
commercial interne





Bureau Limburg
Vinzenz-Pallotti-Strasse 3
65552 Limburg | Germany
Téléphone: +49 2736 497 611
E-Mail: info@prinzling-pfeiffer.com
www.prinzling-pfeiffer.com

MSM Formenbau GmbH
Industriestrasse 9
56459 Langenhahn | Germany

Masa GmbH
Masa-Strasse 2 | 56626 Andernach | Germany