

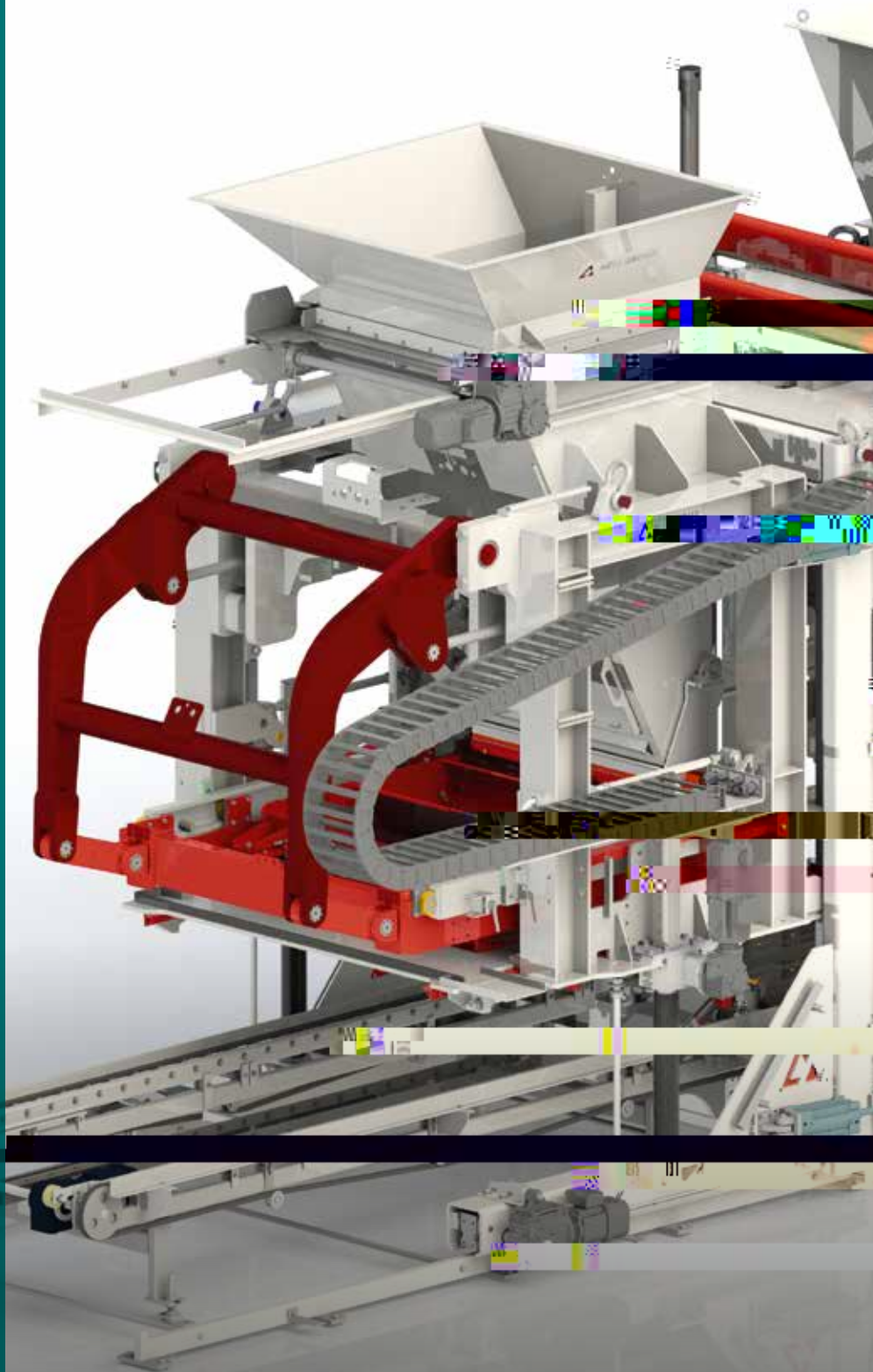

HESS GROUP

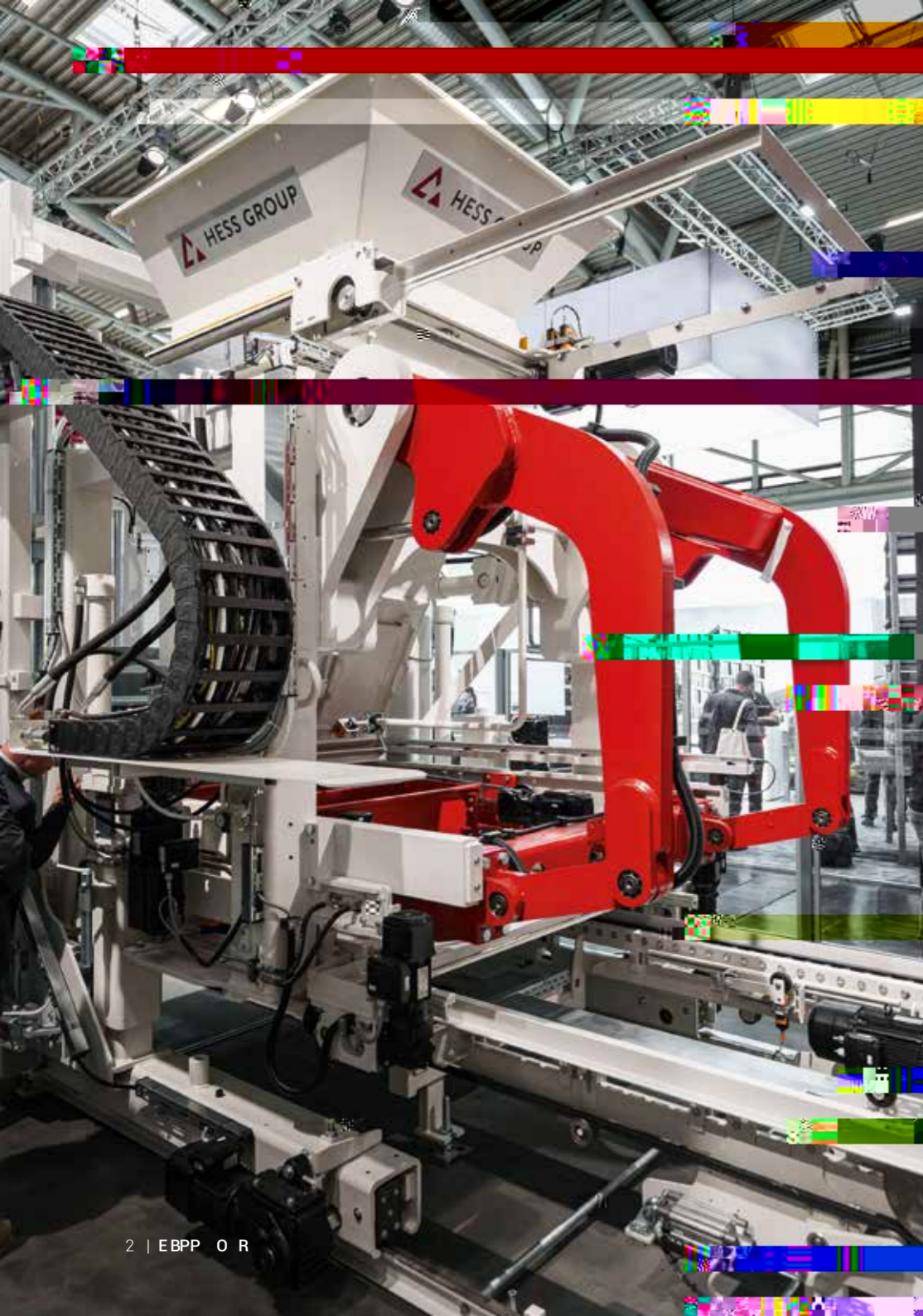



WER IST
HESS GROUP?

HESS GROUP
WELTWEIT

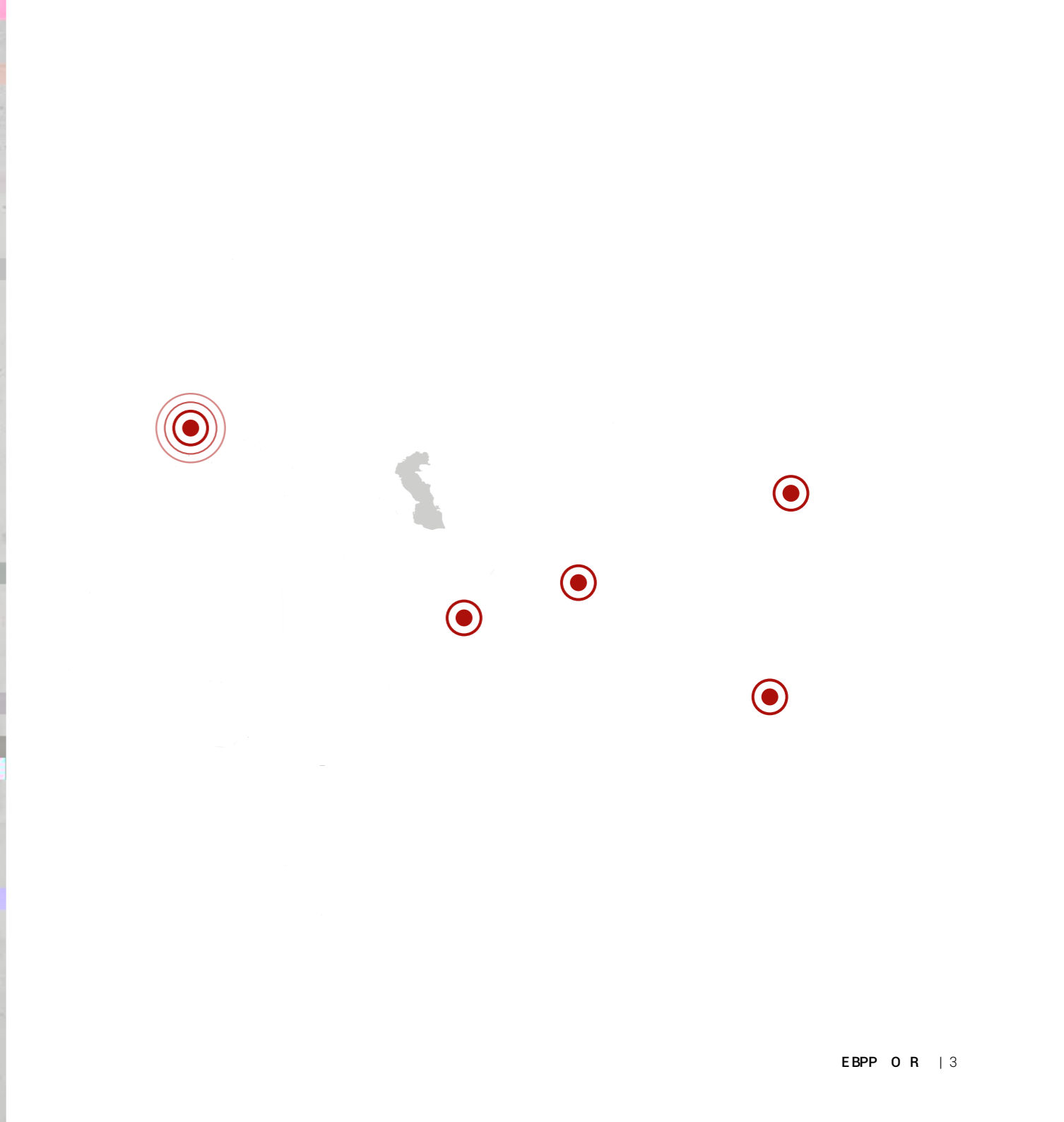

VISION

an m

Ob

MISSION

effizient zu produzieren. Dabei stehen die folgenden 4 Faktoren im Vordergrund:

Hn ab

F a o an b E ab

WERTE

Als innovativer Hersteller hochwertiger
Betonsteinanlagen sichern wir –
gemeinsam mit unseren Kunden –
unsere beidseitige Marktführerschaft



n mm

F o m

Hn ab n

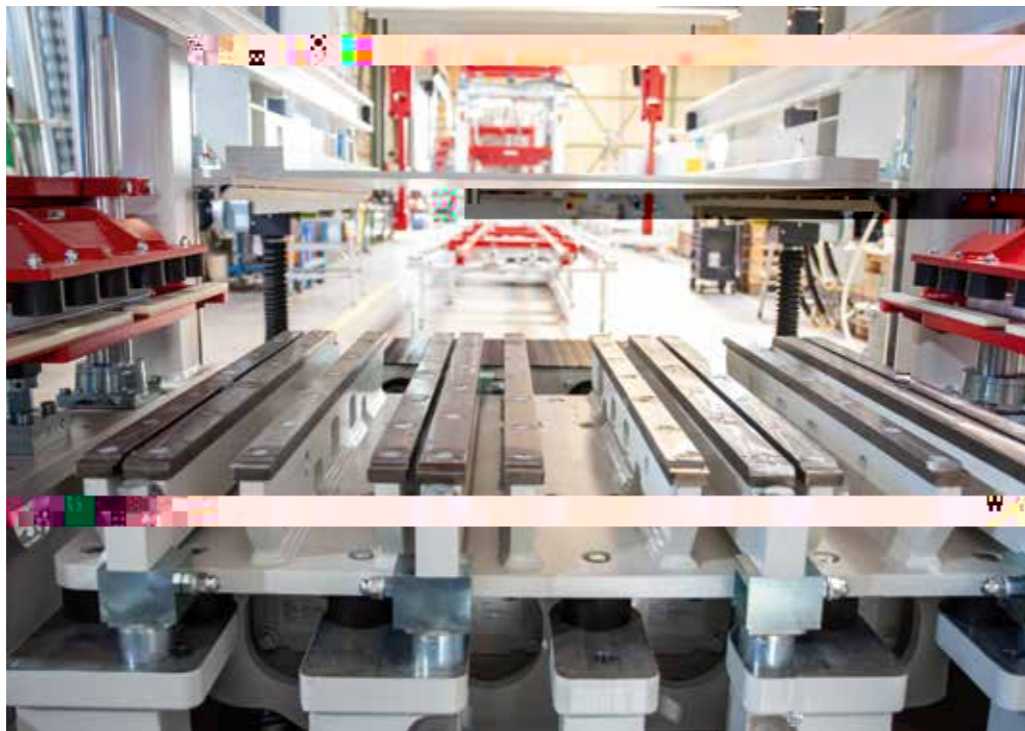
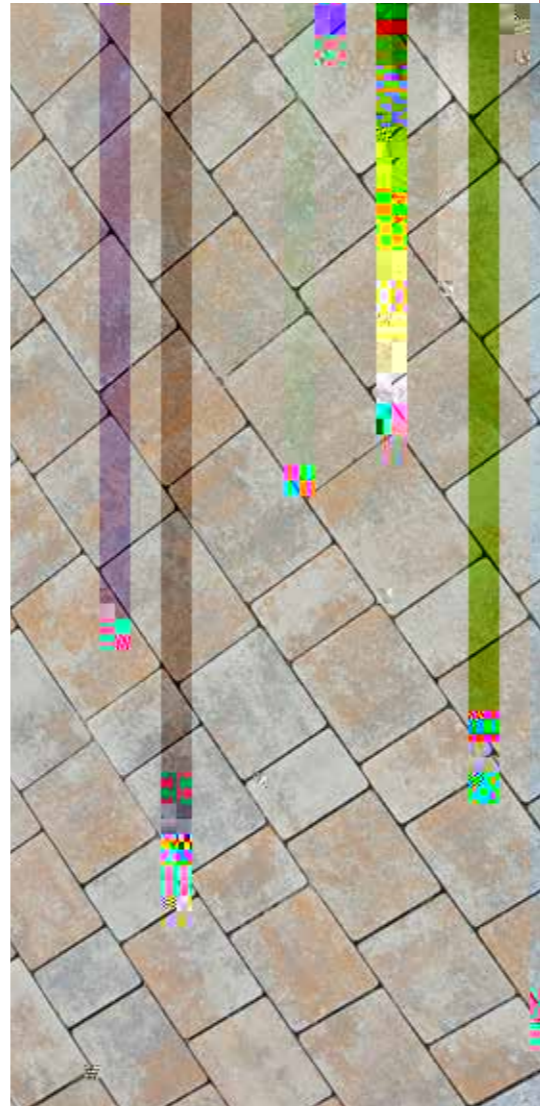
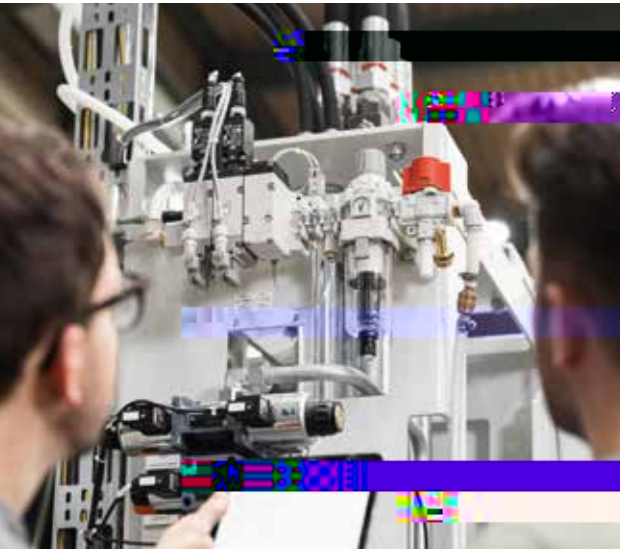

**WIR
BRINGEN
BETON
IN FORM.**

BETONSTEINMASCHINE
RH 1450

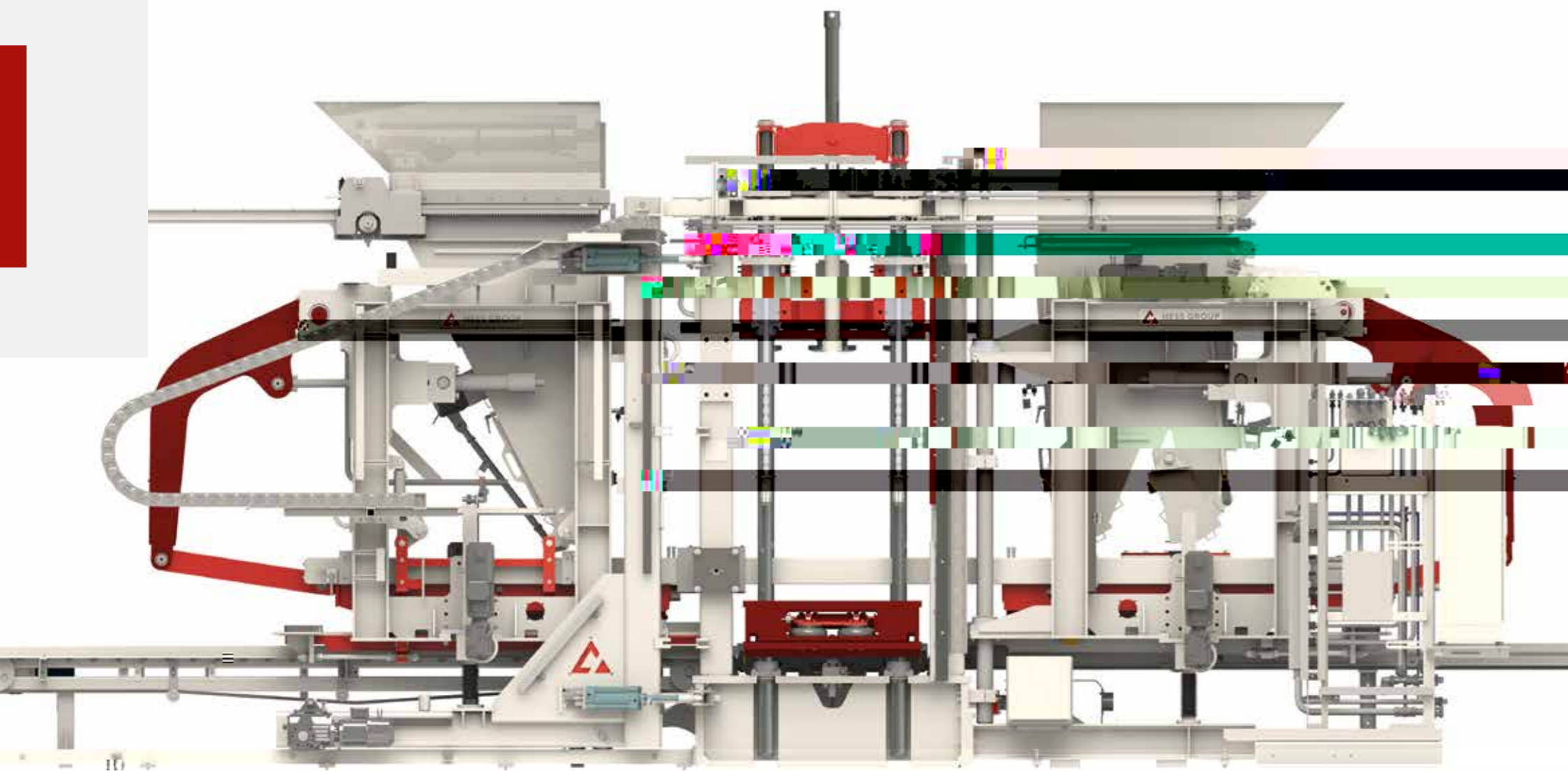

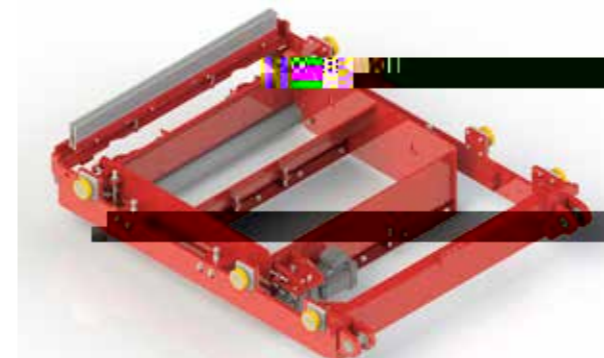
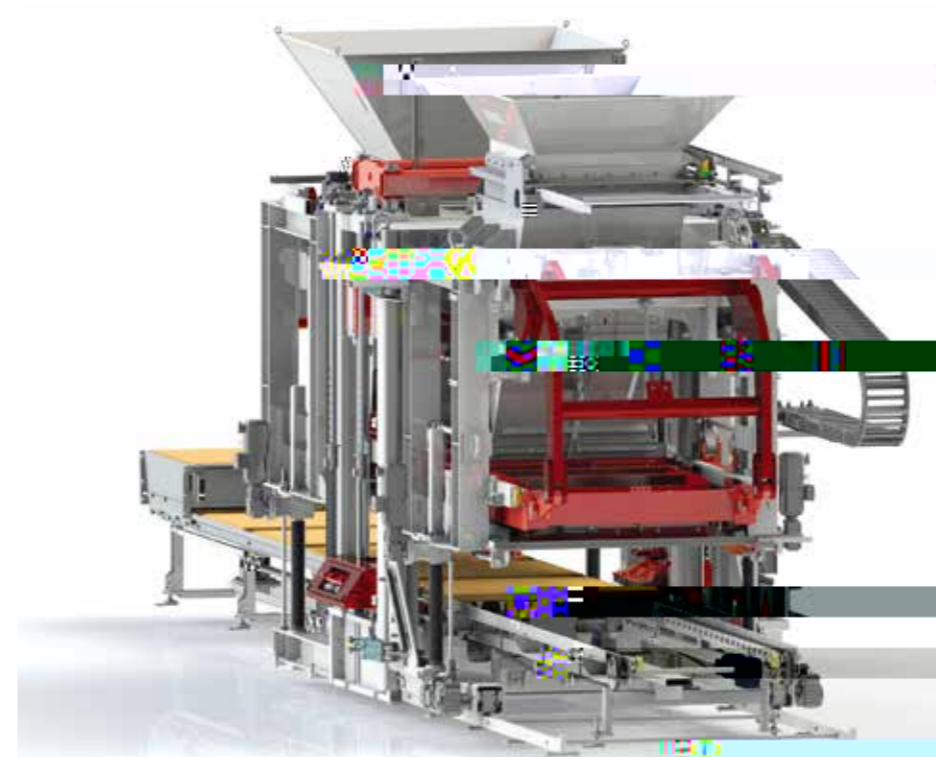

-
-
-



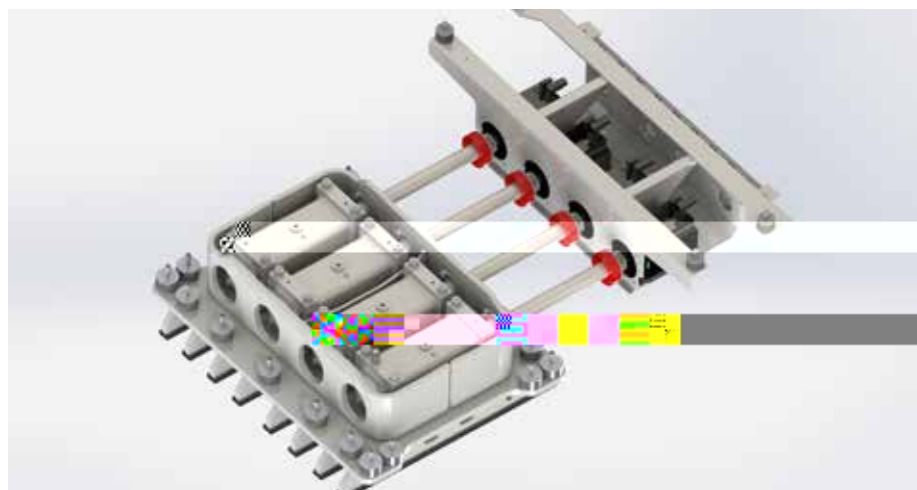
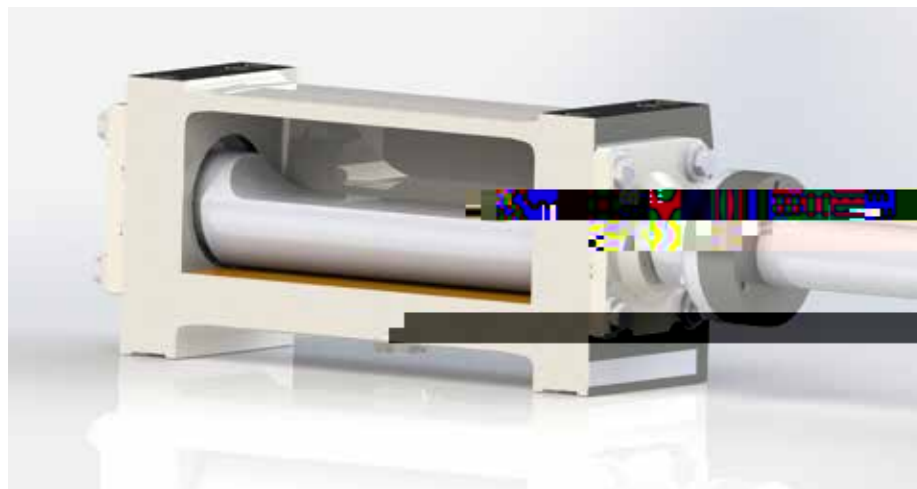

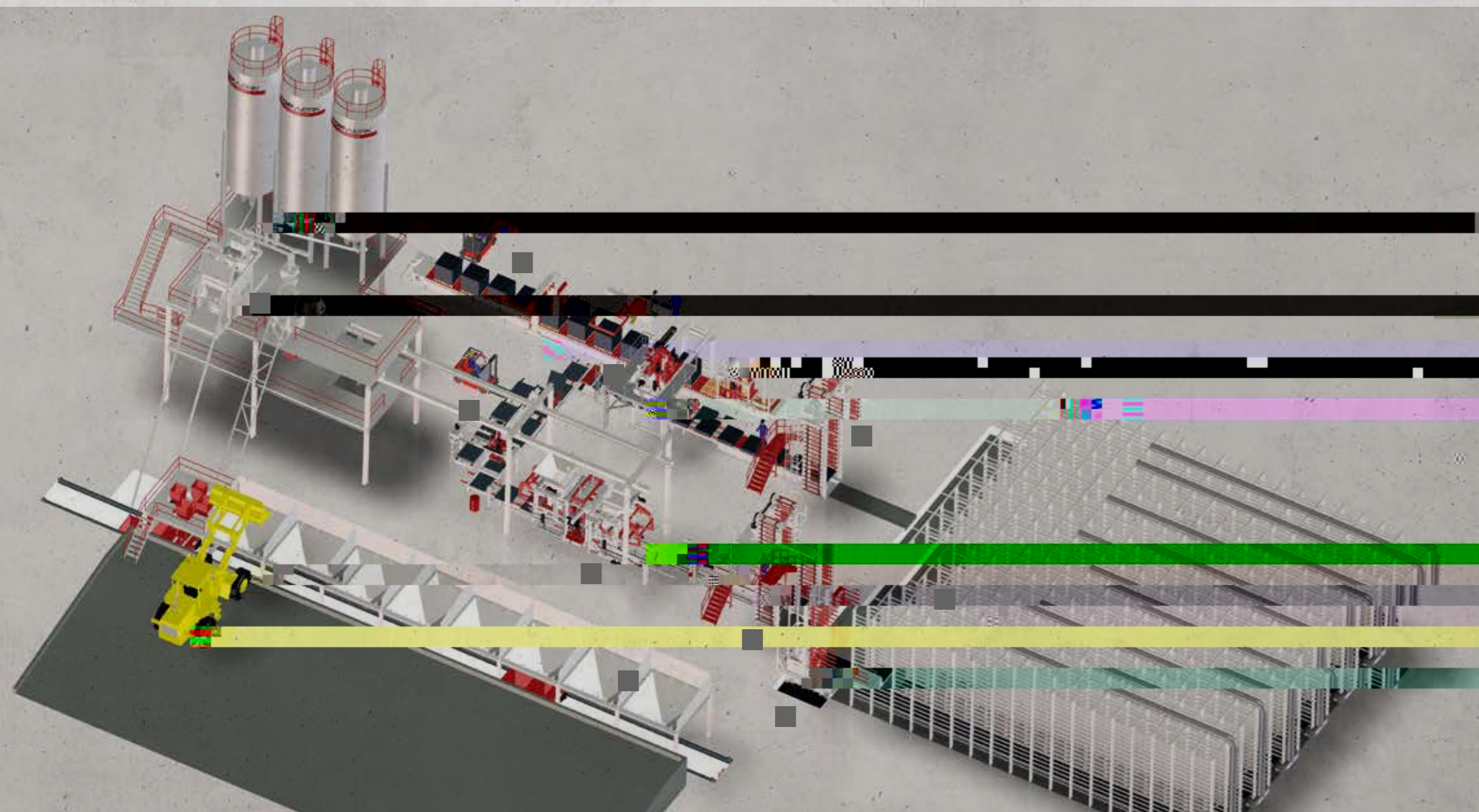

RH 1450 VA

KOMPLETTANLAGEN

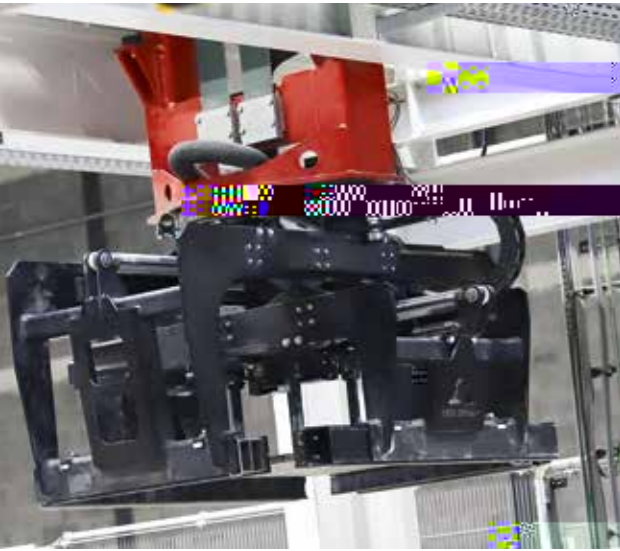

**WIR
BRINGEN
BETON
IN FORM.**

SONDERANLAGEN
**DOSIER- UND
MISCHANLAGEN,
FÖRDERTECHNIK UND
HANDLING**



**DOSIER- UND
MISCHANLAGEN**



Innenansicht Mischer mit Material

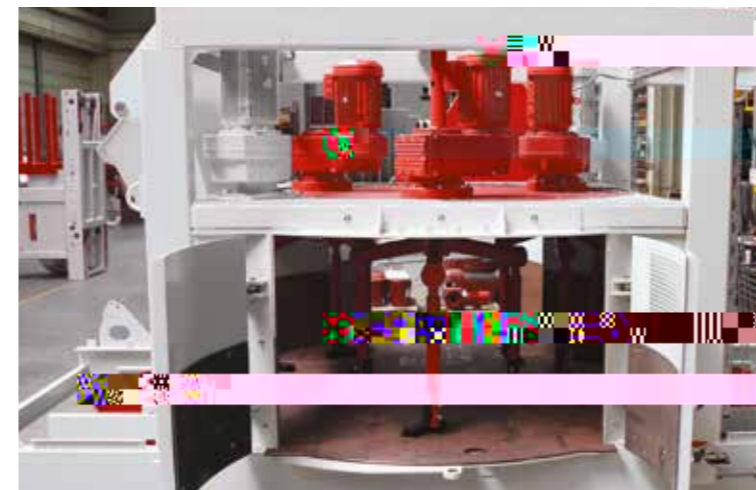

Innenansicht Mischer



Colormix Dosierstation

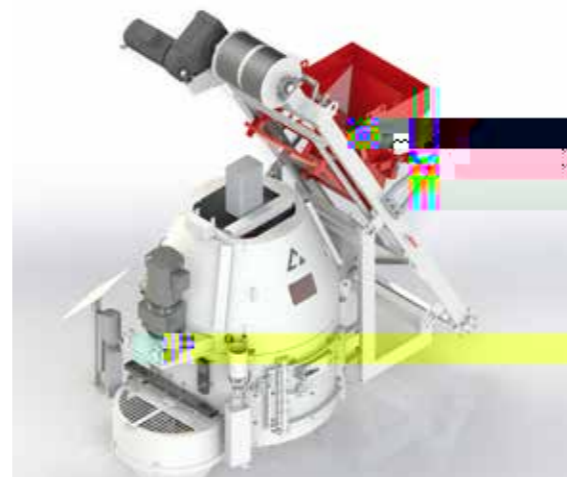

Vorsatzmischer SM 500

-
-
-



